



Trimod®

EN

ENGLISH

3



Index of contents

1	Foreword	6
1.1	Overview	6
1.2	Purpose of the manual	6
1.3	Where and how to keep the manual	7
1.4	Manual update	7
1.5	Collaboration with the user	7
1.6	Manufacturer	7
1.7	Responsibilities of the manufacturer and guarantee	7
1.8	Copyright	8
2	Technological description	9
2.1	Technology Trimod®	9
2.2	Features	9
2.3	Models	12
2.4	Communications device	20
2.4.1	RS232 serial ports	20
2.4.2	Relay interface	20
2.4.3	Logic Level Interface	21
2.4.4	Communications slot	21
2.4.5	Power module block diagram	22
2.4.6	Interconnection block diagram	22
3	Safety provisions	23
3.1	General notes	23
3.2	Symbols	23
3.3	Definitions of “operator” and “specialized technician”	23
3.3.1	Qualification required to the operator	23
3.3.2	Qualification required to the specialized technician	24
3.4	Individual protective gear	24
3.4.1	Gear to wear	24
3.5	Indications of danger in the work place	25
3.5.1	Indications on board the equipment	25
3.6	Residual risks	25
3.7	General warnings	26
3.8	Emergency interventions	26
3.8.1	First aid interventions	26
3.8.2	Fire prevention measures	26

Index of contents

4	Unpacking	28
4.1	Visual inspection	28
	4.1.1 Checking the equipment and accessories supplied	28
4.2	Unpacking	28
4.3	Checking the contents of the pack	28
4.4	Storing	29
	4.4.1 UPS	29
	4.4.2 Batteries	29
4.5	Handling	30
4.6	Positioning	30
4.7	Last operations	31
5	Installation	32
5.1	Safety rules and regulations	32
	5.1.1 Mains connections for TN systems	33
	5.1.2 Mains connections for TT systems	34
5.2	Electrical connections	35
	5.2.1 Safety recommendations	35
	5.2.2 Preliminary operations	35
	5.2.3 Connecting the loads	35
	5.2.4 Emergency Power Off (Remote E.P.O.)	36
	5.2.5 Installing the Trimod® BATTERY	36
	5.2.6 Protections	39
	5.2.7 Earthing	39
	5.2.8 Connecting the power supply	39
	5.2.9 Wiring	40
5.3	Wiring diagrams	40
	5.3.1 THREE-PHASE input, THREE-PHASE output	41
	5.3.2 THREE-PHASE input, SINGLE-PHASE output output connections	45
	5.3.3 SINGLE-PHASE input, SINGLE-PHASE output connections	45
	5.3.4 SINGLE-PHASE input, THREE-PHASE output connections	48
	5.3.5 SINGLE-PHASE input connections no. 3 separate outputs	49
	5.3.6 UPS Trimod® 30TM connections	52

6	Configuration and Start-up	53
6.1	Input configuration	53
6.2	Output configuration	53
6.3	Checks prior to switching ON	53
6.4	Starting procedure	53
7	Control panel	56
7.1	"Service Mode" function	57
7.2	Main menu and submenus	57
7.2.1	UPS status	61
7.2.2	UPS settings	64
7.2.3	Power Modules	67
7.2.4	Events	69
7.2.5	Tools	69
7.2.6	Logout	70
7.2.7	Turning the single output phases ON and OFF	70
7.2.8	Shutting down the UPS Trimod®	70
8	Diagnostics	71
8.1	Luminous and acoustic signals	71
8.2	Messages	73
9	Maintenance	80
9.1	Introduction	80
9.2	Preventive maintenance	80
9.3	Periodical checks	80
9.3.1	Preparing the UPS for maintenance. Forced bypass mode	80
9.4	Adding or replacing a power module or battery drawers	81
9.4.1	Power Module	81
9.4.2	Exit from the maintenance manual bypass	81
9.4.3	Battery drawers	82
10	Dismantling	83
10.1	Disposing of the batteries	83
10.2	Dismantling the UPS	83
10.3	Disposing of the electronic components	83
11	Tables	84

1. Foreword

1.1 Overview

Congratulations for having bought a LEGRAND® UPS Trimod® product.

Thanks to UPS Trimod® unit your critical equipment will be protected by a constant and reliable supply of power for years to come.

LEGRAND® is based in Italy and specializes in designing and producing UPS units. The UPS Trimod® system is unique, modular and the last generation of three-phase medium power UPS units.

Highly reliable, low running costs and excellent electrical performance are but a few of the great features of this innovative UPS. Moreover, the criteria and methods that LEGRAND® uses for its design and production comply with the strictest quality standards. The product is, in fact, produced at an ISO14001 certified factory in full compliance with the eco-design laws.

The UPS Trimod® system is made in compliance with the existing European Community directives and with the technical standards that include their requirements as certified by the Declaration of Conformity issued by the Manufacturer and enclosed with this manual.

This publication, simply defined 'manual' herein, contains all the information for the installation, use and maintenance of the equipment specified in the Declaration of Conformity.

This equipment will be referred to simply as 'equipment' or even 'machine' in this manual and is manufactured by LEGRAND®.

The contents of this manual are intended for an operator who has already been instructed on the precautions to be taken in relation to the presence of electricity.

The persons to whom this publication is addressed, normally defined 'users', are all those people who, for their field of expertise, have the need and/or obligation to provide instructions or work directly on the equipment.

These people can be the following:

- managers;
- heads of operating areas;
- department heads;
- operators directly concerned with transporting, storing, installing, using and servicing machines from the moment they are put on the market up to the day they are scrapped;
- direct private users.

The original text of this publication, written in the Italian language, is the only reference for solving any disputes concerning the interpretation of translations into Community languages.

This publication is to be considered an integral part of the equipment supplied and, as such, must be kept for future reference up until the equipment is definitively dismantled and scrapped.

1.2 Purpose of the manual

The purpose of this manual is to provide indications for using the equipment safely and to carry out routine maintenance procedures.

Adjustments and extraordinary maintenance jobs are not dealt with in this manual as they are reserved exclusively to the assistance technician who must observe to the technical and design characteristics for which the equipment was made when working on it.

It is essential that this manual is read through but it is not a substitute for the expertise of the technical personnel who must have had adequate preliminary training.

The intended use and configurations envisaged for the equipment are the only ones allowed by the Manufacturer; do not attempt to use the equipment in disagreement with the indications given.

Any other use or configuration must be agreed on beforehand with the Manufacturer in writing and, in such a case, will be an enclosure to the manual.

For its use the user must also comply with the specific laws on work that exist in the country where the equipment is installed.

Reference is also made in this manual to laws, directives, etc., that the user must know and consult in order to fulfil the purposes established by the manual.

1.3 Where and how to keep the manual

This manual (and its enclosures) must be kept in a safe, dry place and always be available for consultation.

We suggest making a copy and filing it.

If information is exchanged with the Manufacturer or assistance personnel authorised by the former, please refer to the equipment's rating plate data and serial number.

The manual must be kept for the equipment's useful life cycle and, if necessary (e.g. damage which prevents it being consulted even partially) the user must ask the Manufacturer for a new copy, quoting the publishing code on the cover.

1.4 Manual update

The manual reflects the state of the art at the moment the equipment was put on the market, of which it is an integral part. The publication complies with the directives in force at such a date. The manual cannot be considered inadequate if updates of standards or changes are made to the equipment.

Any integration to the manual which the Manufacturer deems fitting to send to the users, must be kept with the manual, becoming an integral part of it.

1.5 Collaboration with the user

The Manufacturer is available to its clientele to provide additional information and will take into consideration any suggestions made to improve this manual to bring it even closer to the requirements for which it was drawn up.

If the equipment is sold, which always includes handing over this operating manual, the primary user must notify the Manufacturer, giving him the address of the new user so the latter can be reached if there are any communications and/or updates deemed indispensable.

LEGRAND® reserves the property rights of this publication and forbids the total or partial reproduction of it without prior written consent.

1.6 Manufacturer

The equipment's identification data are given on the ID plate.

1.7 Responsibilities of the manufacturer and guarantee

In order to use the guarantee supplied by the Manufacturer the user must scrupulously comply with the precautions indicated in the manual and in particular:

- to always work within the equipment's limits of use;
- to always carry out constant and accurate maintenance;
- to have persons use the equipment with proven capabilities and skill and adequately trained for the purpose;

The Manufacturer declines all liabilities, direct and indirect, resulting from:

- disregard for the instructions and if the equipment is used differently to what is foreseen in the operating manual.
- use by personnel who have not read and understood properly the contents of the manual;
- a use failing to conform to the specific laws existing in the country of installation;

1. Foreword

- changes made to the equipment, software, operating logic that were not authorised by the Manufacturer in writing;
- unauthorised repairs;
- exceptional events.

When the equipment is sold to a third party this manual has to go with it; if the manual is not given to the new user then all purchaser rights are automatically invalidated, including guarantee terms where applicable.

If the equipment is sold to a third party in a country of a different language it is the responsibility of the original user to provide a true translation of this manual in the language of the country where the equipment is going to be used.

1.8 Copyright

The information in this manual must not be disclosed to third parties. Any duplication, total or partial, not authorised in writing by the Manufacturer, obtained by photostatting, duplicating or any other method, even electronically, violates the copyright conditions and can be persecuted by law.

2. Technological description

2.1 Trimod® Technology

Congratulations on your purchase of a UPS Trimod® product from LEGRAND®.

Thanks to the UPS Trimod® your critical equipment will be protected by a constant and reliable supply of power for years to come.

LEGRAND® has developed a project that is both innovative and unique, creating Trimod®, the UPS with a power range of 10, 15, 20, 30, 40 and 60 kVA capable of adapting itself at any time to the changing requirements of protected loads: greater power, longer autonomy, redundancy.

The basic concepts of the Trimod® project are, in fact, modularity, expandability and redundancy which, besides offering maximum reliability, are also the guarantee of a considerable economic saving.

Trimod® is a modular uninterruptible power supply unit with individually programmable basic modules so you can have the input/output configuration you want. In this way it is possible to control three- and single-phase voltage in input and output to have, as preferred the classical three/three, three/single, single/three and single/single lines but it is not limited to just this: you can also have single- and three-phase lines in output simultaneously or two or more single-phase lines also of different powers (on request).

And then, for each configuration it is possible to obtain redundancy, both complete and partial by which we mean that, for example, a normal (or redundant) threephase line plus a redundant (or normal) single-phase line can coexist in output. A microcontroller mounted in each basic module is capable of monitoring the main functions of each single power unit, monitoring its correct operation and signalling any malfunctions.

The modularity philosophy has also been used for the batteries which are supplied in single pull-out boxes. THDi = 3% - Power Factor > 0.99 – High Yield – High Reliability – Easy to install and service.

2.2 Features

Redundant modular architecture

Redundant modular architecture is the best way to protect a company's critical points.

Advantages:

- There is just one control of the devices powered
- Modular Expandability
- Module redundancy
- Easy to service
- Low running cost
- Compact size

Yield

The UPS units of the Trimod® line place particular attention on the energy taken from the mains and that supplied to the user points. High Yield (>94%), PFC in Input >0.99, THDi 3%.

Advantages:

- Increasing the yield means reducing the part of power absorbed by the UPS but not supplied at the load and transmitted to the environment in the form of heat.
- Less heat dispersed in the environment means reducing the use of aerating or conditioning systems on the installation premises.
- PFC in input means no rephasing costs and consequently no increased rates.
- No need to oversize a generator (if used) upstream from the UPS

Expandability

The majority of UPS units on the market is neither modular nor expandable and therefore initial oversizing of the system is necessary to ensure future expansions (which might not even happen).

Advantages:

- The modular and expandable Trimod® systems allow optimisation of the investments made in UPS units, adapting them to actual requirements without preventing future expansions and avoiding an unnecessary waste of energy.
- System yield is increased thanks to correct sizing

Reliability

To have a redundancy level with traditional UPS units it is necessary to put at least 2 in parallel, thus doubling the power bought, the space taken up and the electricity consumed. Instead Trimod®'s modular architecture allows redundant configurations inside just one single cabinet.

2. Technological description

Advantages:

- A UPS with a modular redundant architecture can be configured as an N+X system redundant in power; even in the case of a failing module the equipment carries on working and there is no stop in work.
- Clear indications and a large display speed up troubleshooting.
- The modular architecture makes short work of repairing a failure by simply replacing the module in question without interrupting service.
- A high resolution percentage of failures at the first assistance intervention.

Power module

The basic module, available in three power sizes, 3,400 VA, 5,000 VA and 6,700 VA, is basically made up of the following functional blocks: command and control logic (microprocessor controlled), rectifier/PFCr, inverter, booster, battery charger, automatic bypass.

The power unit is the Plug & Play type to facilitate power expansion and all maintenance works. Each module is paralleled with other identical ones until the UPS power is reached.

The power modules are separate from each other and can work even if one malfunctions. A LED on the front of the module, with a traffic-light code, quickly shows the operating state of the electronic unit.

Prescription forms for PM4, PM6 and PM7 only on the related cabinets: UPS Trimod® electrical distribution equipment is sized for its nominal power and must be used only with power modules originally installed.

Each cabinet must use only the provided power modules, described in table "Mechanical properties" on page 18 of this manual. It is not possible to use power modules other than those indicated, nor mix with other models and/or replace the type of modules.

- The model, the power rating and the type of power module to be installed in the UPS cabinet UPS Trimod® are indicated on the user manual and on the label inside the door of the UPS.
- The type and power rating of the power module are indicated on the label affixed to the bottom of the power module for proper identification.

It is recommended to use only provided UPS Trimod® Power Modules.

Battery drawers

The battery modules are designed for easy insertion in the cabinet with no work needed to connect them; they are easy to handle thanks to their light weight, likewise any maintenance or replacing.

A box holds 5 12V, 7.2 Ah or 9 Ah batteries connected in series and, thanks to the Plug & Play connection can be easily pulled out and put inside the cabinet. In order to guarantee maximum safety, especially during maintenance, the voltage of each box is adequately disconnected into two 24 and 36V branches and restored only when the box is placed right inside its housing. This conforms to the CEI-EN 60950 standard on electrical safety which establishes that adequate safeguards must be used and particular attention where there are dangerous voltages higher than 50 Vdc with the possibility of direct contact.

Autonomy can be increased further still by adding other battery 'boxes' in multiples of four, exploiting the space inside the UPS and the space in the additional 'modular cabinets

Digital display and displaying alarms

Trimod® is controlled by a microprocessor and has a backlit alphanumeric liquid crystal display (LCD) with 20 characters on 4 lines built into the front of the UPS where there is also a highly luminous operating status indicator which, by means of a traffic-light code, indicates the operating status and any alarm conditions.

Four simple push buttons near the display allow the user to: see operating data, set operating parameters, analyse the state of each single power module, select the language in which to see the messages and execute a set of functional tests.

BCM (Battery Charger Module)

It works together with internal PM chargers, with the same intelligent management of the charging cycle. For each BCM installed the maximum batteries recharging current is increased of 15Adc: 1 BCM has a charging current equivalent to that of 6 (internal to the charger) PMs. This guarantees to reduce charging time in installations that require long backup time UPS and increases the availability of the UPS system after a power failure (blackout).

During operation, the module draws current from the phase input (slot) in which it is installed. If at least n°1 PM is present, it is possible to install any number of BCM.

All informations about BCM are indicated by LED on the front of the module and described on the display menu. The module is controlled by a microprocessor to optimize performance and reliability, we recommend the use in combination with higher than 60Ah capacity batteries.

Input voltage 230V +15% -20%, rated output power 4kW, maximum rated current 15Adc, maintenance voltage 13.75Vdc/ battery. Operating status through the UPS front panel LEDs and multi-colored, adjustable fan speed versus power output, overtemperature protection.

Intelligent charging cycle with four stages to maximize battery life (constant current, final charge, maintenance and stand-by).

Off-Line Mode

The UPS Trimod® provides a mode of operation off-line that allows to save power while still providing the protection of the continuity of power supply to the connected load. During the operation Off-Line, the load is powered directly by the mains through the automatic internal bypass circuit in power modules.

This means that the voltage and the output frequency are the same as the network input, and the UPS Trimod can not control these variables. The benefit that you get in the Off-Line mode is greater electrical efficiency since UPS doesn't work. If the output voltage goes out of tolerance range ($\pm 15\%$ of the set voltage output) or is lacking, the UPS activates its stage inverter powering the load with the energy stored in the batteries.

The runtime during battery operation depends on the configuration of the UPS (full load, battery capacity) and the percentage of applied load. When AC input is within the parameters of tolerance, the UPS automatically returns to the Off-Line mode. And it is possible to change the operating mode between On-Line and Off-Line (and vice versa) when the UPS is ON or OFF (entering Service Mode).

- To activate the Off-Line, enter the Main Menu -> Settings UPS -> Bypass -> Off-Line Mode and select Enabled, confirm the selection with the Enter button.
- To activate the On-Line, enter the Main Menu -> Settings UPS -> Bypass -> Off-Line Mode and select Disabled, confirm the selection with the Enter button.



WARNING!

If the load needs to be fed without any interruption or with a regulated voltage amplitude and/or frequency it is recommended to use the UPS Trimod® mode On-Line double conversion.

2. Technological description

2.3 Models

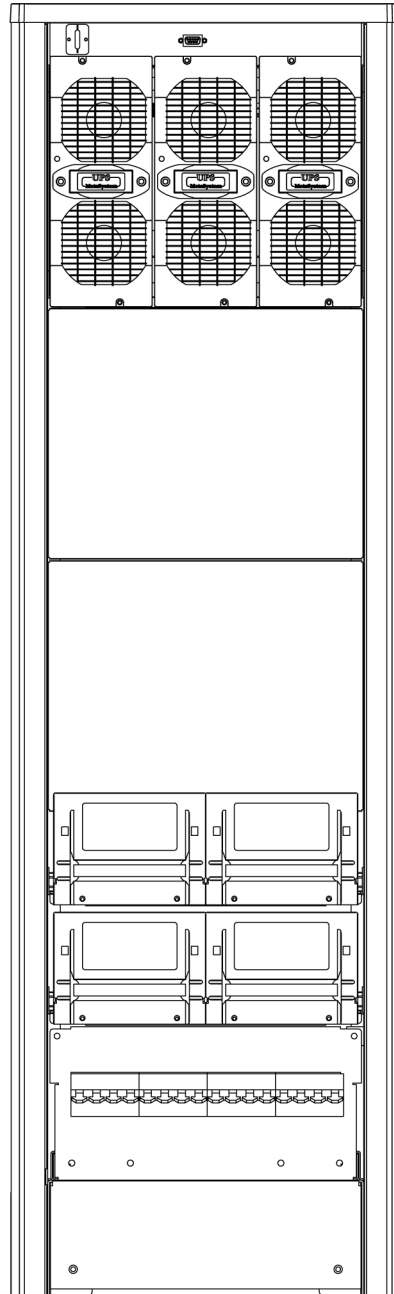

UPS Trimod[®] 10

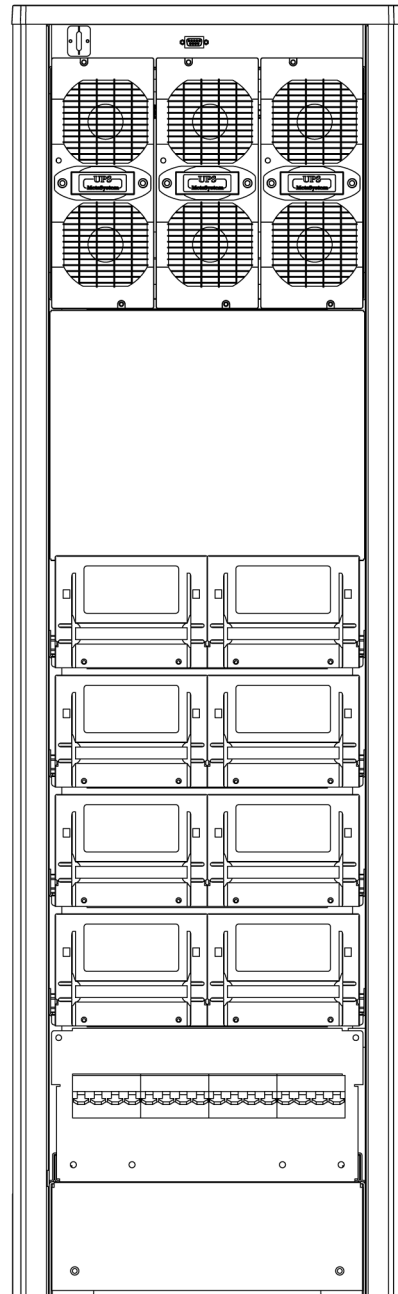

UPS Trimod[®] 10/15/20

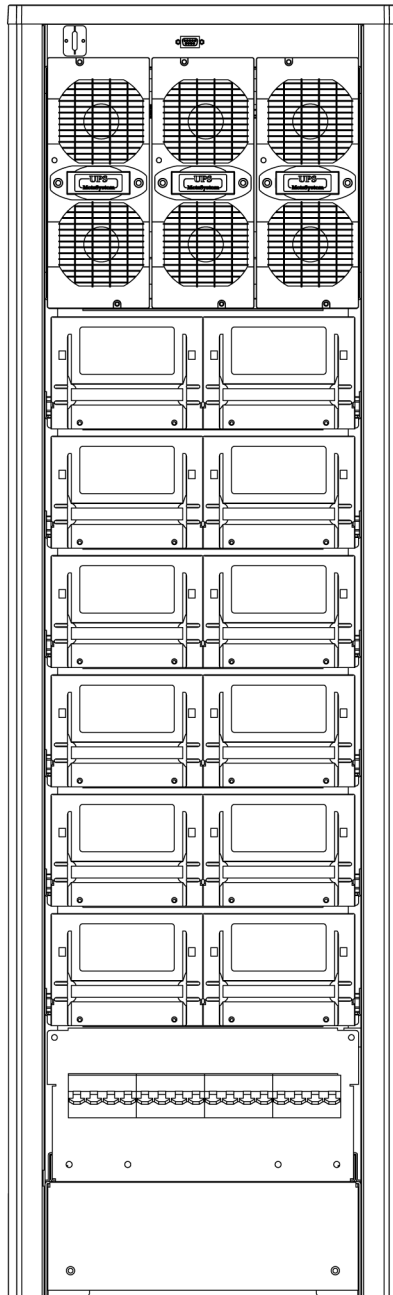

UPS Trimod® 10/15/20

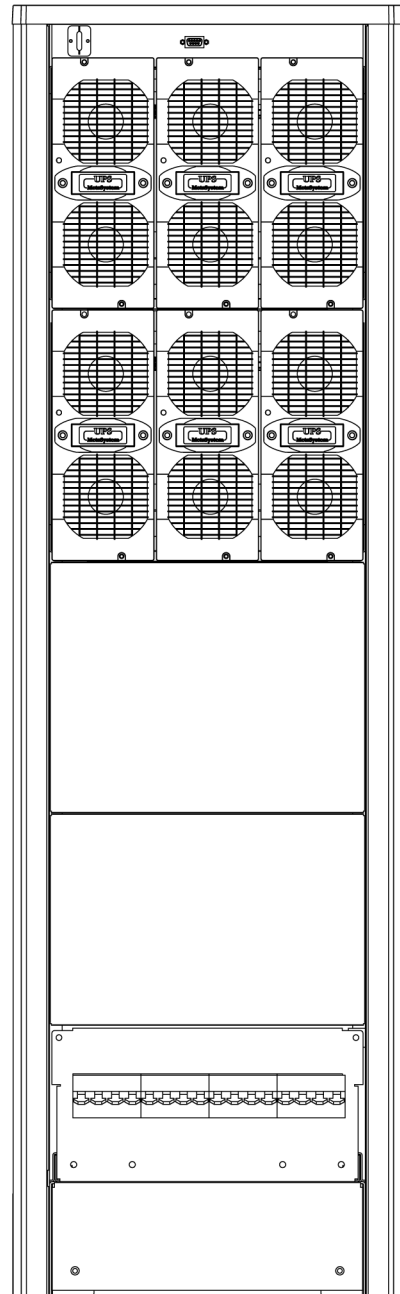

UPS Trimod® 30 TT

2. Technological description

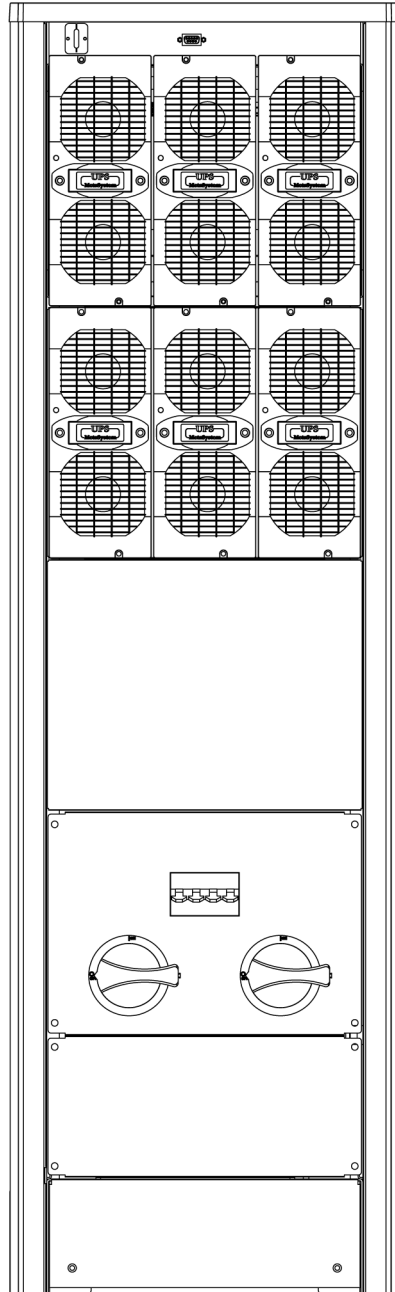

UPS Trimod[®] 30 TM

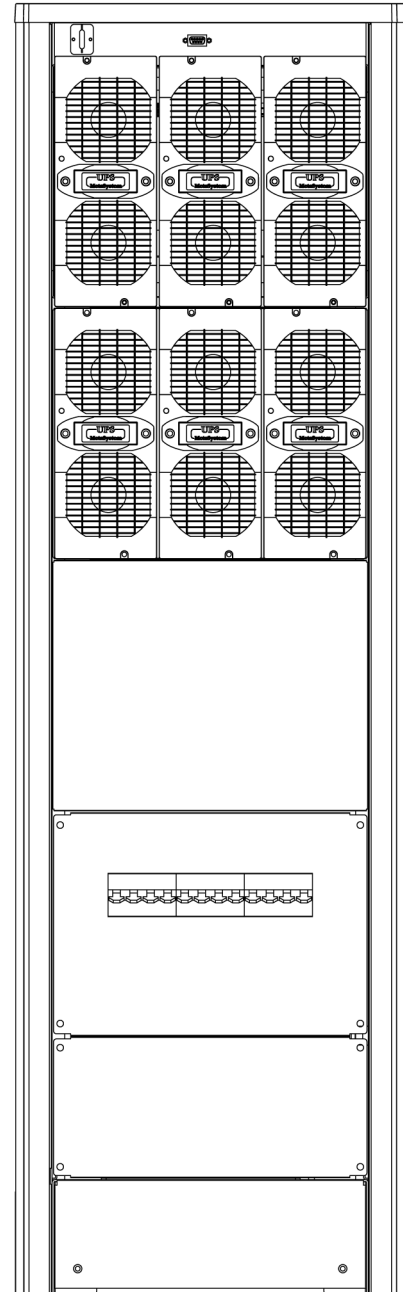

UPS Trimod[®] 40

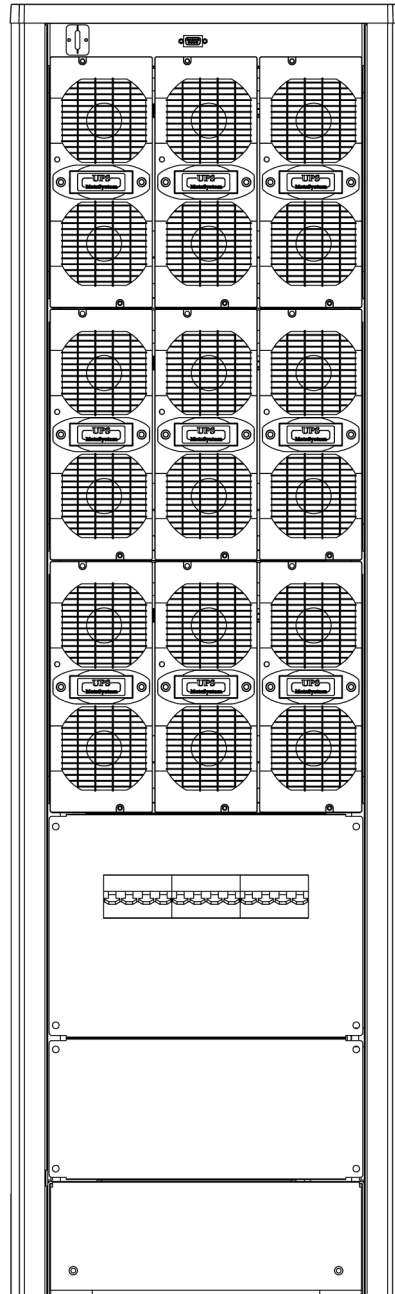

UPS Trimod® 60

2. Technological description

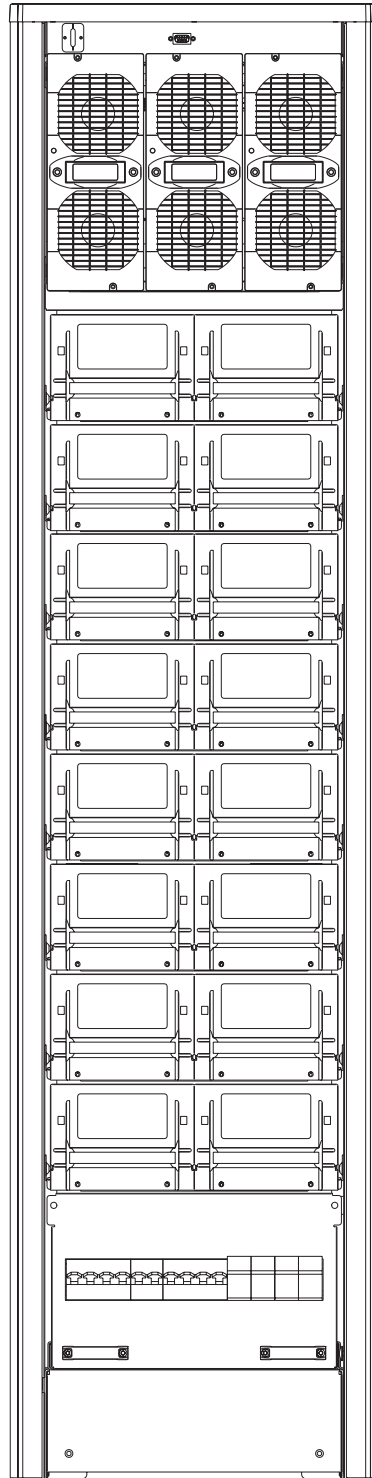

UPS Trimod[®] 10/15/20

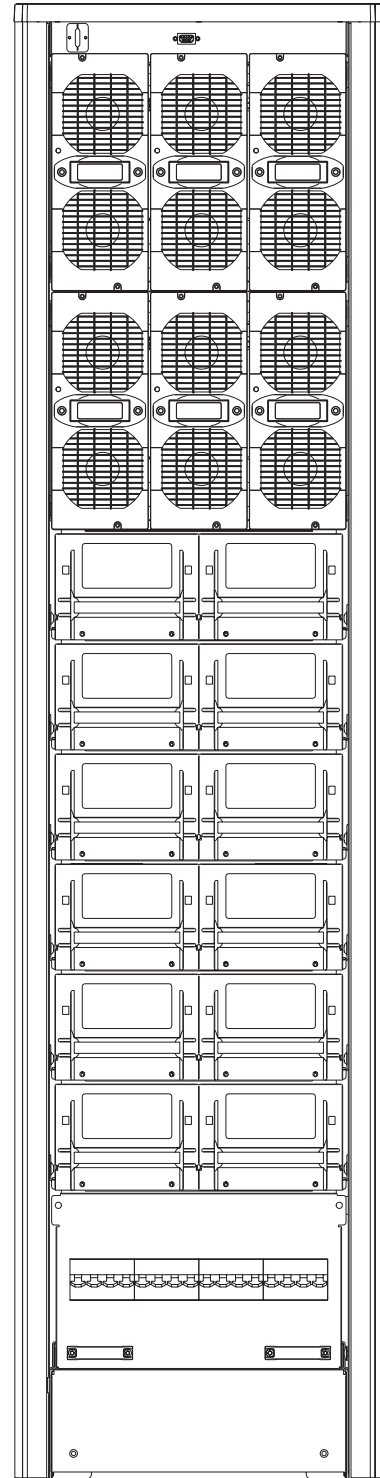

**UPS Trimod 20Kva 6 SLOT
UPS Trimod 30TT with internal batteries**

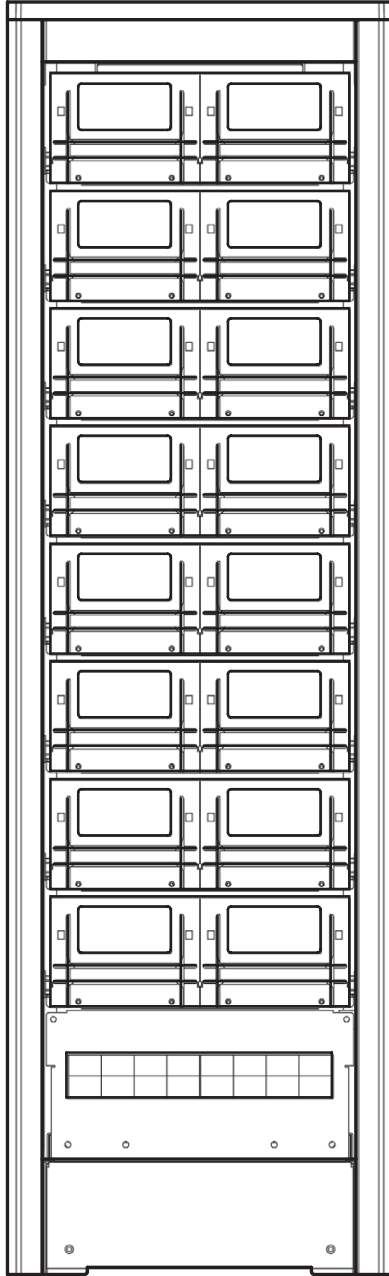

UPS Trimod® BATTERY

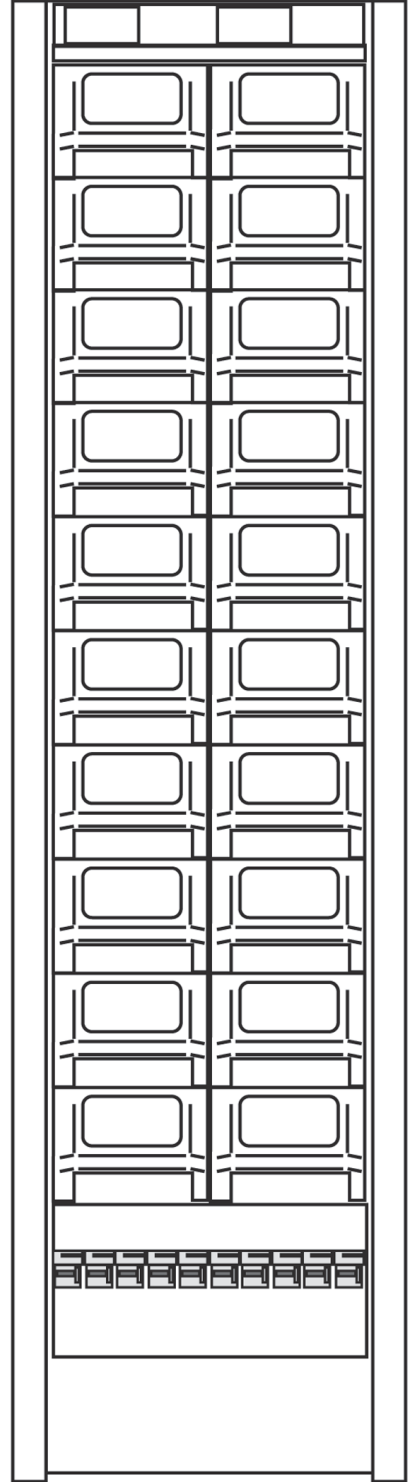

UPS Trimod® BATTERY/2

2. Technological description

General characteristics

	3 104 22 3 104 31 10 kVA	3 104 23 3 104 32 3 104 33 15 kVA	3 104 23 3 104 32 3 104 33 20 kVA	3 104 25 30 kVA TM	3 104 24 3 104 34 30 kVA TT	3 104 26 40 kVA	3 104 27 60 kVA
Rated Power	10 kVA	15 kVA	20 kVA	30 kVA	30 kVA	40 kVA	60 kVA
Active Power	10 kW	15 kW	20 kW	30 kW	30 kW	40 kW	60 kW
Technology	On Line, double conversion IEC 62040-3 VF I – S S - 111						
IN/OUT configuration	Single / Single – Single / Tri – Tri / Single – Tri /Tri (can be configured by user)				Tri / Tri		
UPS architecture	Modular with 3400 VA - 5000VA - 6700VA power modules housed in a single cabinet Expendable, Redundant N+X.						

Input

	3 104 22 3 104 31 10 kVA	3 104 23 3 104 32 3 104 33 15 kVA	3 104 23 3 104 32 3 104 33 20 kVA	3 104 25 30 kVA TM	3 104 24 3 104 34 30 kVA TT	3 104 26 40 kVA	3 104 27 60 kVA
Maximum current (Three-phase - Three-phase)	19.2 A	28.8 A	38.4 A	57.6 A	57.6 A	76.8 A	115.2 A
Maximum current (Three-phase - Single-phase)	19.2 A	28.8 A	38.4 A	57.6 A	-	-	-
Maximum current (Single-phase - Three-phase)	57.6 A	86.4 A	115.2 A	172.8 A	-	-	-
Maximum current (Single-phase - Single-phase)	57.6 A	86.4 A	115.2 A	172.8 A	-	-	-
Input voltage	230 V + 15% - 20% (Single-phase) 400 V + 15% - 20% (Three-phase) (Neutral line is essential)				400 V + 15% - 20% (Three-phase) (Neutral line is essential)		
Input frequency	50 / 60 Hz						
Power factor on the input	> 0.99						
THD input current	< 3%						

Output

	3 104 22 3 104 31 10 kVA	3 104 23 3 104 32 3 104 33 15 kVA	3 104 23 3 104 32 3 104 33 20 kVA	3 104 25 30 kVA TM	3 104 24 3 104 34 30 kVA TT	3 104 26 40 kVA	3 104 27 60 kVA
Maximum current (Three-phase - Three-phase)	14.5 A	21.7 A	29 A	43.5 A	43.5 A	58 A	87 A
Maximum current (Three-phase - Single-phase)	43.5 A	65.2 A	87 A	130.5 A	-	-	-
Maximum current (Single-phase - Three-phase)	14.5 A	21.7 A	29 A	43.5 A	-	-	-
Maximum current (Single-phase - Single-phase)	43.5 A	65.2 A	87 A	130.5 A	-	-	-
Output voltage	230 V ± 1% (Single-phase) 400 V ± 1% (Three-phase)				400 V ± 1% (Three-phase)		
Static tolerance of output voltage	1%						
Output frequency	50 / 60 Hz synchronized						
Wave shape	Sinusoidal						
Mains efficiency (AC/AC on line)	up to 96%						
Mains efficiency (AC/AC eco mode)	99% max						
Tolerated overload	115% for 10 min – 135% for 60 s						

Batteries

	3 104 22 3 104 31 10 kVA	3 104 23 3 104 32 3 104 33 15 kVA	3 104 23 3 104 32 3 104 33 20 kVA	3 104 25 30 kVA TM	3 104 24 3 104 34 30 kVA TT	3 104 26 40 kVA	3 104 27 60 kVA
Type of batteries	12V 7.2Ah or 12V 9Ah maintenance-free sealed lead batteries						
Tolerated overload	115% for 2 min – 135% for 30 s						

Accessories

	3 104 22 3 104 31 10 kVA	3 104 23 3 104 32 3 104 33 15 kVA	3 104 23 3 104 32 3 104 33 20 kVA	3 104 25 30 kVA TM	3 104 24 3 104 34 30 kVA TT	3 104 26 40 kVA	3 104 27 60 kVA
Bypass	Automatic (static and electromechanical) Manual (for maintenance)						
Signals and alarms	Large alphanumeric display with 4 lines, multicolored status indicator, buzzer						
Communication ports	Two RS 232 ports, 1 relay interface, 1 contact port						
Software	Can be downloaded free of charge from the web site www.ups.legrand.com						
Protections	Electronic against overloads, short-circuits and excessive battery discharging. Functions blocks if autonomy ends. Powering surge limiter. E.P.O. contact (total shutdown in an emergency) BackFeed Protection.						

Mechanical characteristics

	3 104 22 10 kVA	3 104 23 15 kVA	3 104 23 20 kVA	3 104 25 30 kVA TM	3 104 24 30 kVA TT	3 104 26 40 kVA	3 104 27 60 kVA
Net weight UPS (without batteries)	110 Kg			130 Kg		154 Kg	
Dimensions UPS (L x H x D) (mm)	414 x 1367 x 628						
3400VA Power modules installed	3						
5000VA Power modules installed		3		6	6		
6700VA Power modules installed			3			6	9
Power modules - Net weight	8 Kg						
Battery drawing - Net Weight	14 Kg						

	3 104 31 10 kVA	3 104 32 20 kVA	3 104 33 20 kVA	3 104 34 30 kVA TM			
Net weight UPS (without batteries)	130 Kg						
Dimensions UPS (L x H x D) (mm)	414 x 1650 x 628						
3400VA Power modules installed	3	6					
5000VA Power modules installed				6			
6700VA Power modules installed			3				
Power modules - Net weight	8 Kg						
Battery drawing - Net Weight	14 Kg						

2. Technological description

Environmental conditions

	3 104 36 10 kVA	3 104 37 15 kVA	3 104 37 20 kVA	3 104 39 30 kVA TM	3 104 38 30 kVA TT	3 104 40 40 kVA	3 104 41 60 kVA
Operating temperature	0°C ÷ 40°C						
Relative humidity	20% ÷ 80% non-condensing						
Noise level at 1m	58 ÷ 62 dBA						
Grade of protection	IP 21						
Maximum altitude	up to 1000m without derating						

Bcm technical specifications

INPUT	
Rated voltage and tolerance	230 Vac +15% -20%
Rated current	19.3 Arms
Power Factor	PF > 0.99
Input current THD	THDi < 3%

OUTPUT	
Maintenance voltage	13.75 Vdc/battery
Rated current (max)	15 Adc
AC/DC Efficiency	>93% at max rated current

INDICATIONS	
Operating mode (multi-color LED on the module and display menu information on the UPS)	Yellow LED, Fast intermittent: f1 recharge fase. Green LED, Slow intermittent: f2 recharge fase and maintenance. Green LED, fi xed: stand-by Red LED: Fault mode

STANDARD
EN 62040-1, EN 62040-2, EN 62040-3

2.4 Communication devices

The uninterrupted power supplies of the UPS Trimod® family have 2 RS 232 serial ports, 1 relay interface and 1 output on a 9-pole male tray-shaped connector, logic level SELV. insulated.



ATTENTION

To ensure operator safety it is mandatory for the interfaces to be connected so that:

- the maximum voltage between any two conductors connected to the interface and between either of these two conductors and earth is less than a peak 42V or less than 60Vdc;
- the insulation voltage between any conductor connected to the interface and earth is at least 1500Vac

2.4.1 RS232 serial ports

The first of the two RS232 serial ports used on the uninterrupted power supply unit and called "maintenance interface" is located at the top behind the front door. It is dedicated exclusively to diagnostic functions and updating machine firmware.

The second, called "user interface", is at the top at the back of the UPS. Thanks to this port that, with either a computer or specific network card, it is possible to access UPS operating data and to control the unattended turning off of the operating system.

2.4.2 Relay interface/E.P.O.

The default setting of the relay interface contacts is Normally Open (NO) but can be configured as Normally Closed (NC) via the UPS display. Inoltre è presente l'ingresso per la funzione E.P.O.

The indications available with this interface are:

- running on battery
- autonomy reserve
- generic alarm
- overload
- UPS running on bypass

Electrical specifications/contact interface

The technical specifications of the relay interface contacts are the following:

- $V_{MAX} = 250VAC - 30VDC$, $I_{MAX} = 5A$

E.P.O. input

Voltage with open contacts 12VDC, current with closed contacts 5mA.

The indications available with this interface are the following:

G

PIN	FUNCTION
1 -2	Running on battery
3 - 4	Autonomy Reserve
5 - 6	Generic alarm
7 - 8	Overload

H

PIN	FUNCTION
1 -2	Running on Bypass
3 - 4	E.P.O.
5 - 6	-

2. Technological description

2.4.3 Logic level interface

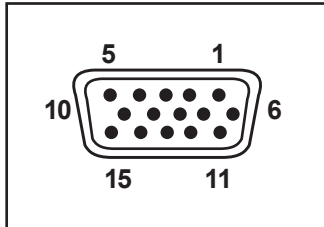

Logic level interface is available on connector DB15 (F) and it allows the UPS to be connected to a remote system for monitoring its operating status, making available the following indications and controls:

- Mains/battery operated;
- Autonomy reserve
- UPS fault
- Overload
- UPS on bypass
- ON/OFF input

The functions of the interface pins are:

- Pin 1: GND;
- Pin 2: Mains/Battery (output, active high);
- Pin 3: Autonomy Reserve (output, active high);
- Pin 4: RS232 power supply;
- Pin 6: do not connect
- Pin 7: Overload (open collector, active low);
- Pin 12: UPS on Battery (open collector, active low);
- Pin 13: UPS on Bypass (open collector, active low);
- Pin 14: Autonomy Reserve (open collector, active low);
- Pin 15: Alarm (open collector, active low)..

Electrical specifications

Logic output: 12V_{DC} max., output impedance 2.2kΩ in series.

RS232 power supply: 12V_{DC} 700mA max., not adjusted.

Open collector outputs (all): 30V_{DC} 100mA max

2.4.4 Communication slot

In the rear part of UPS Trimod® an SNMP Slot is available for SNMP Adapter (Optional).



ATTENTION

The maximum current taken from pin4 of connector DB15 "RS232 power supply" and from the SNMP slot for the network board to work must be, in total, less than 700mA.

2.4.5 Power module block diagram

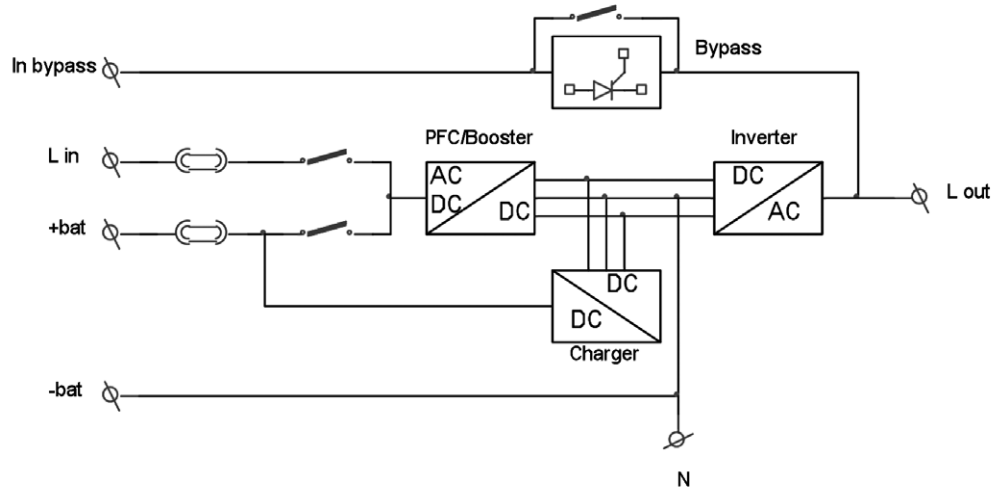

2.4.6 Trimod® 30KVA TM Interconnection block diagram

All UPS Trimod® models have a similar block diagram.

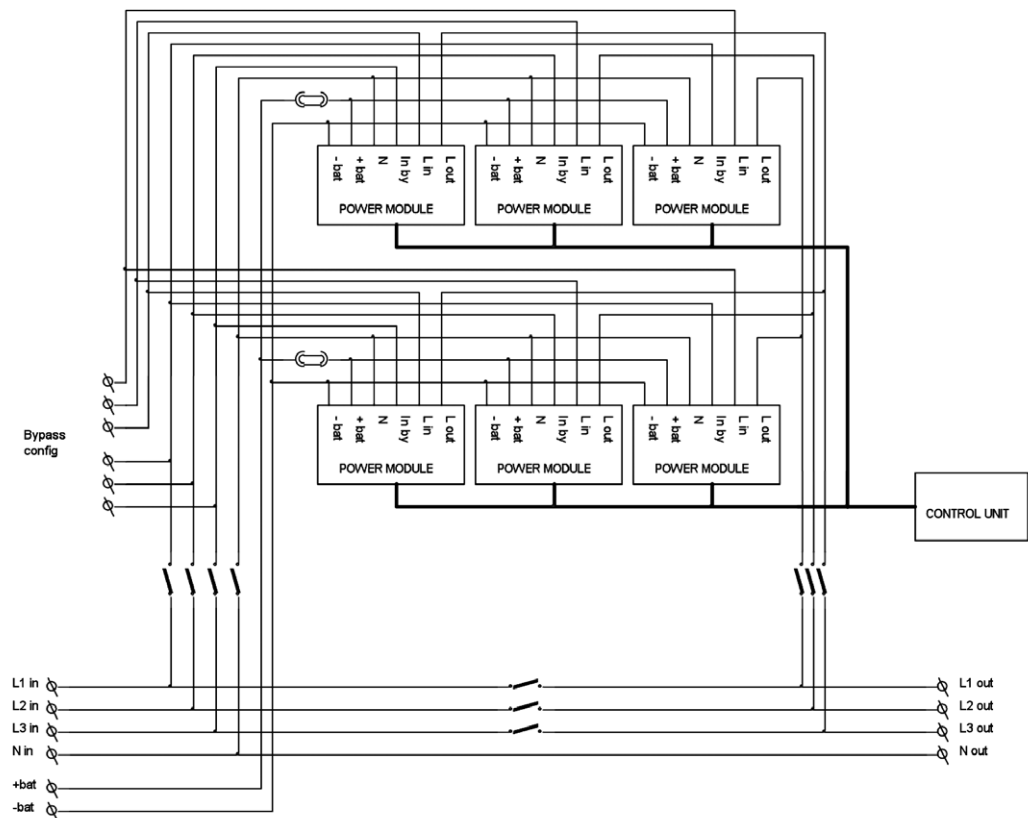

3. Safety Provisions

3.1 General notes

**WARNING**

Before doing any operation on the equipment, it is necessary to read through the whole manual carefully, paying attention to this chapter in particular.

The equipment has been built for the application specified in the declaration of conformity enclosed with this manual. For no reason whatsoever it is allowed to use it for purposes other than those for which it has been designed, nor in ways different to those explained in the manual.

The various interventions must be carried out following the criteria and chronology described in this manual.

3.2 Symbols

In this manual some operations are highlighted by graphical symbols that call the attention of the reader to the dangerousness of the operations. The graphics are as follows:

**WARNING**

This means the possibility of an event happening that could lead to serious injury or great damage to the equipment if adequate precautions are not taken.

**ATTENTION**

This means the possibility of an event happening that could lead to slight injury or material damage if adequate precautions are not taken.

INDICATION

This means important information that must be read paying maximum attention.

3.3 Definitions of 'Operator' and 'Specialized Technician'

The professional figure that is going to access the equipment for normal use is defined by the term "operator".

With this definition we mean personnel who know how to use and service the equipment and have the following requirements:

1. Specific training that authorises them to work according to the safety standards in relation to the dangers that the presence of electricity can bring about.
2. Training on how to use the Individual Protective Devices and on the basic first aid interventions.

When the company person in charge of safety chooses the operator who is to use the equipment – who must be suitable for work in accordance with the existing laws – he must consider the physical aspect (no impairment), the psychological aspect (mental equilibrium, sense of responsibility) and personal education, training, experience and knowledge of the standards, prescriptions and provisions for the prevention of accidents.

Based on the skill and capacity found, he shall also see to the operator's training in order to give him full knowledge of the equipment and of the parts it is made of.

To conclude, the operator must be made aware of the contents of this manual.

3.3.1 Qualification required to the operator

The operator must follow the instructions given to ensure maximum safety for himself and for the others. In particular he must comply with all the requirements contained in this manual throughout all the operating phases.

Typical activities envisaged:

- using the equipment when it is working normally and resetting subsequent to a stop;
- taking the necessary measures to maintain performance quality;
- cleaning the equipment
- collaborating with personnel who are to see to extraordinary maintenance work ("specialized technician").

3.3.2 Qualification required to the specialized technician

The professional person who has to look after installation, starting and extraordinary maintenance is defined by the term "specialized technician".

With such a definition we mean people with knowledge of the procedures for installing, assembling, repairing and servicing the equipment and who have specific technical qualification. Besides the requirements listed for a generic operator, the specialized technician must have had technical training or specific training for the procedures needed to use and service the equipment in complete safety.

Broadly speaking, the specialized technician will be a person selected among the professional people in the department and who has proven experience and capacities and specific technical expertise in relation to the type of work to be done.



WARNING

The person in charge of safety is responsible for the protection against and prevention of company risks in accordance with the European Directive 89/391 EEC (safety at the work place), in ITALY it is part of the Law Decree dated 12/11/1994.

The person in charge of safety must ensure that all people working on the machine have received all the relevant instructions of this manual, included start-up and commissioning, and with particular reference to the contents of this chapter.

3.4 Individual protective gear



WARNING

There is a high risk of electrical shock with the equipment as well as a considerable short circuit current. When using and servicing the equipment it is absolutely forbidden to work without the protective gear mentioned in this paragraph.

The personnel who are going to work and/or transit near the equipment must not wear clothes with baggy sleeves or laces, belts, bracelets or other metal items that could be a hazard source.

3.4.1 Gear to wear

The following indications summarise the protective gear to wear.



Accident and spark proof footwear with rubber sole and reinforced toe
Use: always



Waterproof rubber gloves
Use: always



Protective gear
Use: always



Protective glasses
Use: always

3. Safety Provisions

3.5 Indications of danger in the work place

The following signs must be placed in all points of access to the premises where the equipment is installed.



Electric current
It indicates the presence of live parts.



Emergency interventions
Do not use water to extinguish a fire but only the extinguishers designed specifically for putting fires out on electronic equipment.



No smoking
This indication explains that it is forbidden to smoke in the area where the sign is affixed.

3.5.1 Indications on board the equipment

The explanatory plates on the equipment can vary according to the country of destination and to the relative applicable construction laws.

Strictly comply with what is required. It is strictly forbidden to remove these plates or to work in a way different from what is indicated on them.

All the data on the plates must always be readable and cleaned periodically.

If a plate is ruined and/or is no longer legible, even only in part, ask for a new one from the Manufacturer who is bound to supply a substitute.



WARNING

The plates must be neither removed nor covered; it is forbidden to affix others on the equipment without the prior written authorisation from the Manufacturer.

3.6 Residual risks

'Residual' risks are risks that were impossible to eliminate at the design phase and, as such, are potentially present on the equipment.

These risks are found with a specific analysis as prescribed by the standards of the sector. The documentation relative to the analysis is included in the Technical File of the machine filed by the Manufacturer.

In the case of the UPS Trimod® there are no residual risks provided that all the indications and provisions in this manual are scrupulously complied with.



WARNING

The risk can be drastically reduced by wearing the Individual Protective Gear listed in this chapter, considered indispensable. Always work with due caution when near the dangerous areas indicated by the signs on board the equipment.

3.7 General warnings



ATTENTION

The equipment generates, uses and can radiate energy and radio frequencies. If not installed and used in agreement with the indications given in this manual, it can interfere with radio communications.

- The equipment must be kept and used in accordance with the instructions given herein and as suggested from time to time.
- The department manager must instruct the operating and maintenance personnel on how to use and service the equipment in complete safety.

-
- Only specialized and specifically instructed personnel must be allowed to access the equipment for maintenance work. All the time such maintenance work is being done, 'Work underway' signs must be affixed in the department that can be seen from all access points.
 - Connection of the equipment (and of any accessory devices) must include standard earthing to discharge short circuit current and electrostatic voltages. Mains voltage must correspond to the value on the ID plate. Use of current adapters is not allowed. When connecting pay attention to polarities.
 - Any work on the equipment must be done only after it has been disconnected from the supply mains via the switch which must be padlocked.
 - When the equipment is received, or prior to switching on each time, DO NOT switch the UPS on if the batteries are leaking.
 - Tools used for maintenance (pliers, screwdrivers, etc.) must be the electrically insulated type.
 - It is strictly forbidden to deposit combustible materials near the equipment. It must always be kept locked and access allowed only to specifically trained personnel.
 - Do not deactivate the safety devices or delude the indications, alarms and warnings, whether they are communicated automatically or by means of plates on the installation.
 - Do not turn the machine on without the fixed protections in place (panels, etc.).
 - In the case of breakages, deformation or malfunctions of the equipment or parts of it, repair or replace immediately, avoiding "emergency" repairs.
 - It is not allowed, for any reason, to modify, manipulate or in any way alter the structure of the equipment, the devices mounted on it, operating sequence, etc., without having first consulted the Manufacturer.
 - If the fuses have to be changed, always and only use ones of the same type.
 - Changing the batteries is a job for a specialized technician. Bear in mind that the electrolyte can cause irreparable injury to skin, mucous membranes, and eyes and is toxic if inhaled or swallowed. Always work with the most suitable Individual Protective Gear. Do not forget that the batteries must be disposed of according to the laws existing in the country where the equipment is installed as they are toxic waste. Under no circumstances can a battery be burnt as it would cause an explosion!
 - All maintenance work, routine and extraordinary, must be recorded in a register, noting the date, time, type of job, name of the operator and all useful information. If necessary use the pages added at the end of the "Maintenance" chapter.
 - Do not use oils or chemicals to clean with as they can corrode or damage parts of the equipment.
 - Both the equipment and the work place must be kept perfectly clean.
 - When maintenance is finished check carefully that no tools and/or materials have been left near the equipment before turning the electricity back on.

3.8 Emergency interventions

The following information is of a general nature. For specific interventions please consult the laws existing in the country where the equipment is installed.

3.8.1 First aid interventions

If any first aid intervention is required, comply with company rules and traditional procedures.

3.8.2 Fire-prevention measures

- Do not use water to extinguish fire but only the extinguishers designed specifically for putting fires out on electronic equipment.

4. Unpacking

4.1 Visual inspection

When the UPS is delivered, examine the packaging and product carefully to see if any damage was done during transport. In particular check the integrity of the indicator on the external "Shock Watch" label.

If either possible or ascertained damage is found report it immediately to:

- the carrier;
- the LEGRAND® Technical Assistance Centre

Make sure that the unit received corresponds to the material specified on the delivery document.

The UPS Trimod® packaging protects the equipment against mechanical and environmental damages.

For greater protection it is also wrapped in a transparent film.

4.1.1 Checking the equipment and accessories supplied

The equipment and relative accessories supplied (as agreed with the manufacturer) must be in perfect condition. Before it is shipped the equipment is checked carefully; however, it is always advisable to check it is complete and in order when receiving it.

Make sure that:

- The shipping data (consignee's address, number of packs, order number, etc.) are the same as those written on the accompanying documents;
- The technical-legal documentation that comes with the equipment includes the user manual for the specific type of UPS to install together with the CE Declaration of Conformity.

In the case of defects and/or material missing, send a report immediately to the Manufacturer and wait for his instructions before commissioning the equipment.

4.2 Unpacking

To remove the packing material observe the 'ARROW' on the outside box. To remove the UPS from the packaging follow these steps:

1. cut the wrapping and open the plastic safety straps;
2. open the top of the cardboard box;
3. remove the top protection;
4. remove the four corner protections;
5. remove the packaging container, pulling it upwards;
6. remove the pallet and front/rear bracket from the UPS, loosening the 4 securing screws;
7. inspect the UPS to see if it has been damaged in any way. Notify the carrier and supplier immediately if any apparent damage is found;

Keep the packaging material in case the UPS has to be shipped in the future. The packaging materials are 100% recyclable; if you want to dispose of them please comply with the existing laws.

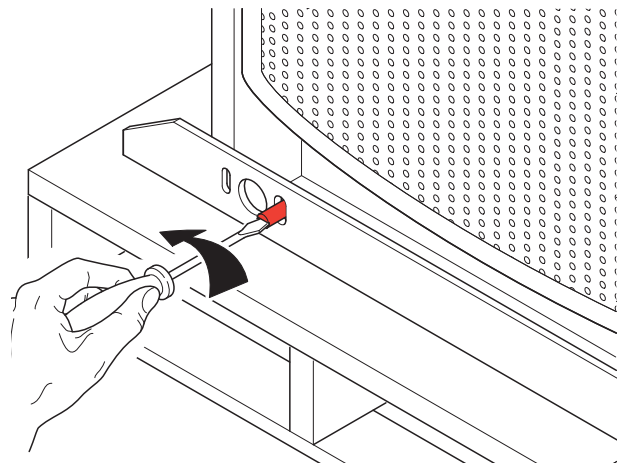

4.3 Checking the contents of the pack

Below is a list of the materials supplied. The list is general. Please refer to the packing list for shipment details.

Trimod® INVERTER

- No. 1 UPS Trimod® unit;
- No. 1 bag of accessories with a set of screws for installing the unit correctly;
- No. 1 front closing panel;
- No. 2 base strips for side closing;
- Operating and maintenance manual
- International guarantee.

Trimod® BATTERY

- No. 1 Trimod® BATTERY cabinet;
- Operating and maintenance manual
- No. 1 multicore cable for connecting to the UPS Trimod® inverter;
- No. 1 bag containing fuses and keys for the front door.

Trimod®/2 BATTERY

- No. 1 Trimod® BATTERY/2 cabinet;
- Operating and maintenance manual
- No. 2 multicore cables for connecting to the UPS Trimod® inverter;
- No. 1 bag containing fuses and keys for the front door.

Check that the UPS Trimod® technical data on the plate on the sticker affixed on the inside panel of the door, inside the hatch of the UPS, correspond to the material bought, described on the delivery document.

4.4 Storing

4.4.1 UPS

If the UPS is going to be stored prior to installation, regardless of whether or not it is still packed, it must be on dry, clean and fresh premises where the ambient temperature is between 0°C and +50°C (32-122°F) and with humidity below 90% (not condensing).

4.4.2 Batteries

The standard batteries of the UPS Trimod® are sealed lead-acid, they are maintenance-free and installed internally. Lead is a dangerous substance for the environment if it is not recycled by specialized companies. If the batteries are not charged they cannot be kept for more than 6 months at 20°C (68°F) or more than 3 months at 30°C (86°F) or more than 2 months at 35°C (95°F).

**ATTENTION:**

sealed batteries must never be stored if they are partly or totally flat.

To charge the batteries before and after storing, simply connect the input power supply to the UPS, plug in battery fuses (F B+ and F B-) and then close the switches. When the unit detects the input voltage it automatically proposes starting a battery charging cycle. After about 1 minute charging starts automatically and the time left to finish charging is shown on the display. The charging cycle can be stopped at any time by pressing the 'ESC' key.

If the UPS is delivered without batteries, LEGRAND® is not liable for any damage or bad operation caused to it by an incorrect wiring of the batteries.

4. Unpacking

4.5 Handling



WARNING

Handle with great care, lifting it only to the extent necessary, keep it well balanced and avoid swinging which could be dangerous.

If it weighs less than 30 kg (check on the transport document) the equipment can be moved around by hand as it has two wheels.

Do not forget that the equipment must always be handled by trained personnel, equipped with the Individual Protective Gear as specified in Chapter 3.

If the equipment needs to be lifted, use a forklift truck or transpallet of a suitable capacity, inserting the forks in the wooden base, making sure they come through on the opposite side by at least twenty centimetres.

4.6 Positioning

The UPS must be placed observing the following conditions:

- humidity and temperature must be within the prescribed limits;
- the fire protection regulations must be observed;
- wiring must be of easy execution;
- the front and rear must be accessible for assistance or routine maintenance;
- the flow of cooling air must be guaranteed;
- the air conditioned system must be adequately sized
- there must be no corrosive/explosive gases
- the premises must be free from vibrations;
- the clearance at the back and sides must guarantee adequate circulation of the cooling air.

Minimum clearances
recommended for
the UPS
X=100 mm / Y=200
mm

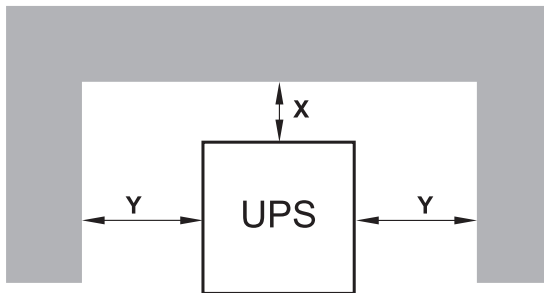

Minimum clearances
recommended for
the UPS Trimod® +
Trimod® BATTERY
X=100 mm / Y=200
mm

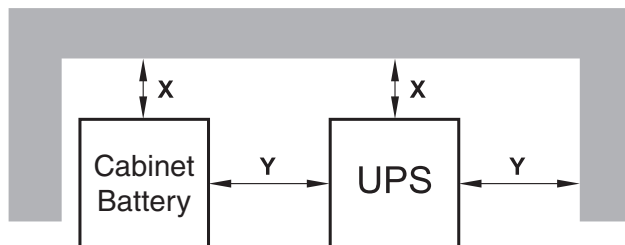

Bear in mind that the average life of the batteries is strongly influenced by the environmental operating temperature. Place the unit on premises where the temperature ranges between +18°C (64.4°F) and +23°C (73.4°F) which will guarantee a very long battery life.

Before commencing installation, make sure there is enough lighting on the equipment so that each single detail can be seen easily. Use artificial lighting if natural lighting is not enough for the aforementioned requirements.

If maintenance work has to be done on parts that are insufficiently illuminated, it is compulsory to use portable lighting, being careful not to create shadows that will prevent or reduce visibility on the point you are working on or on the surrounding areas.

4.7 Last operations

Once positioned correctly, fit the two side base strips and the front one supplied in the accessory kit.

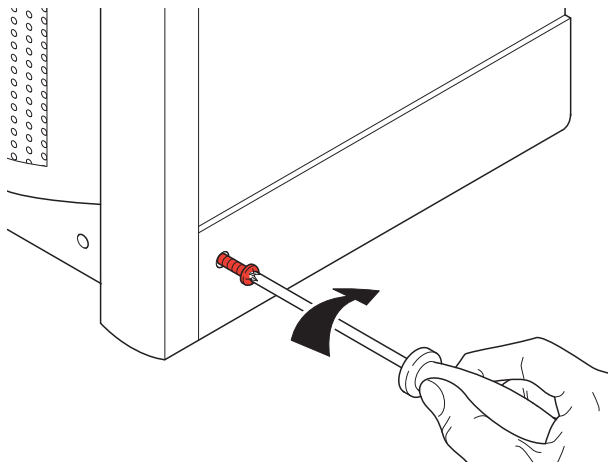

5. Installation



WARNING

The instructions in this chapter are not addressed to a normal operator but to a specialized technician, authorised to work only if he uses the Individual Protective Gear mentioned in Chapter 3.

5.1 Safety rules and regulations

Prima di eseguire qualsiasi operazione di installazione, leggere e applicare quanto di seguito riportato:

1. The installation of the UPS Trimod® units must be provided with a fixed type circuit breaker. There shall be no connection to the mains through a plug of the traditional type.
2. The framework of power supply or disconnection device, must be installed near the equipment and be easily accessible.
3. A circuit protection against return voltage must be provided externally to the UPS (backfeed protection). See diagrams on the next page.
4. You will have to affix a “warning” label on all power disconnects the power supply placed away from the UPS in order to alert the service personnel that the circuit is connected to a UPS. The label must contain the following text (or equivalent):

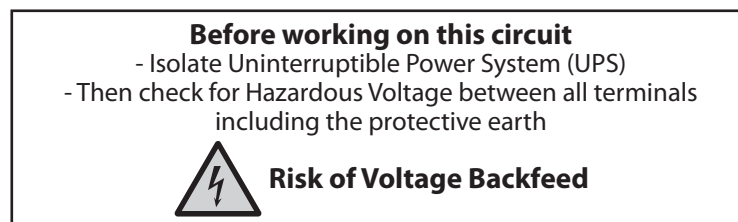

The UPS Trimod® is equipped with an auxiliary contact for enabling the external circuit backfeed protection. The auxiliary contact is made with a relay C / NC / NO and is available on the terminal pole “BACKFEED PROTECTION” in the terminal box of the UPS.

If the UPS detects a condition of return voltage, the relay is energized and changes state, enabling the cutting of input lines that must be realized externally as indicated in the schematic below.

The characteristics of relay contacts are:

- Maximum switching voltage: 250Vac.
- Applicable current: 5A, PF = 1.

5.1.1 Mains connection and Backfeed protection drawings for TN systems

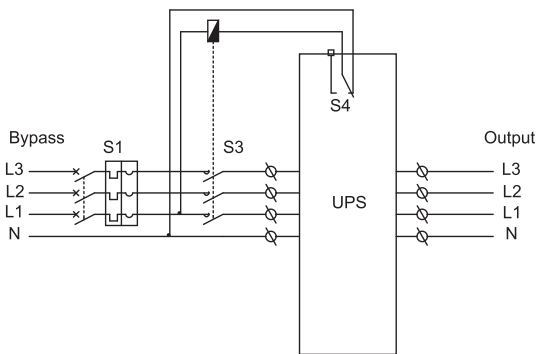

Three-Phase/Three-Phase Configuration

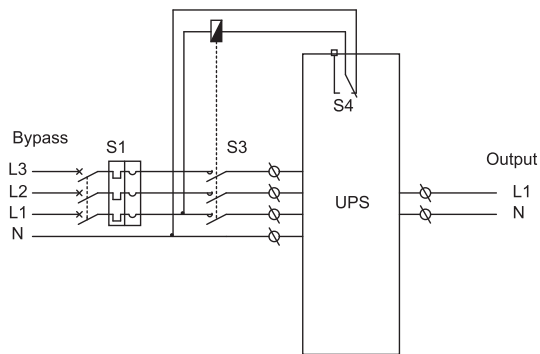

Three-Phase/Single-Phase Configuration

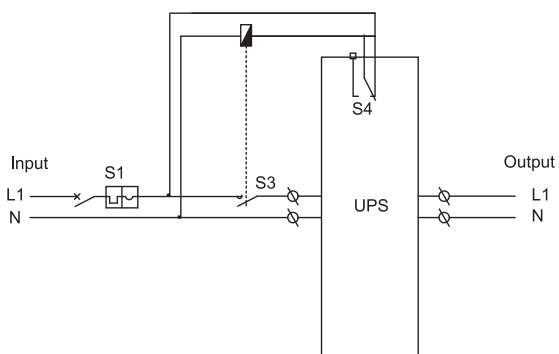

Single-Phase/Single-Phase Configuration

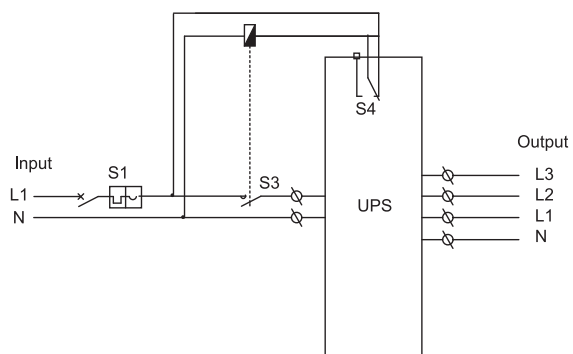

Single-Phase/Three-Phase Configuration

In the diagrams:
 "S1" is the circuit breaker required.
 "S3" is bypass line breaker contact
 "S4" are backfeed protection circuit contacts.

5. Installation

5.1.2 Mains connection and Backfeed protection drawings for TT systems

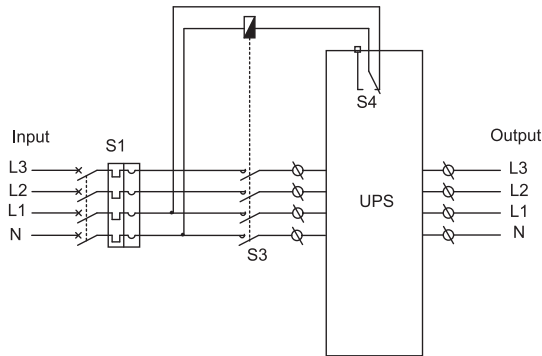

Three-Phase/Three-Phase Configuration

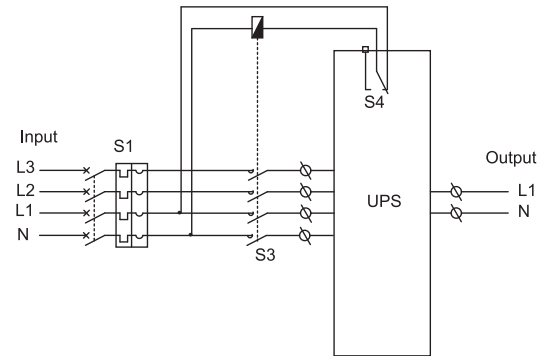

Three-Phase/Single-Phase Configuration

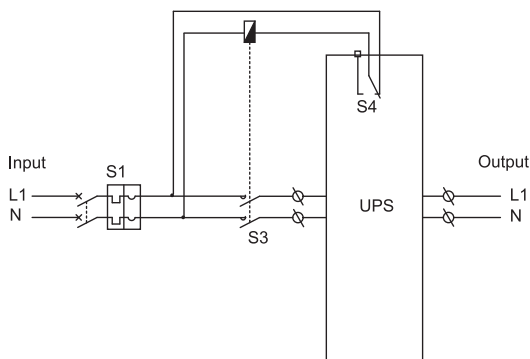

Single-Phase/Single-Phase Configuration

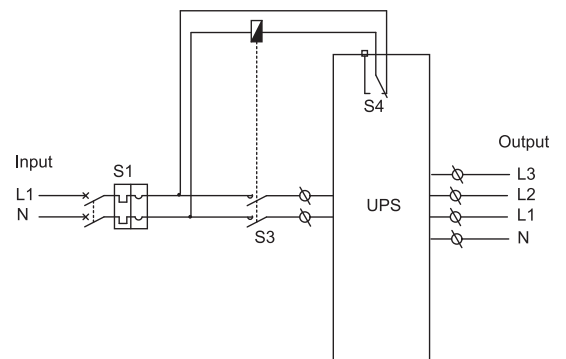

Single-Phase/Three-Phase Configuration

In the diagrams:

"S1" is the circuit breaker required.

"S3" is input line breaker contact

"S4" are backfeed protection circuit contacts.



WARNING

In case of Backfeed Protection warning, please contact Technical Support.

5.2 Electrical connections

The electrical connection of the UPS to the switchboard is part of the installation and is usually done by the user and not by the UPS manufacturer; therefore the following indications are purely an example and the actual electrical connections must be done in accordance with local standards.

Once the UPS has been removed from the packaging and positioned in its final place of installation, the authorised technician can start its installation.

5.2.1 Safety recommendations



WARNING

Before starting please read and apply the following with attention. It is strictly forbidden to proceed with installation if one or more of the following conditions have not been checked.

1. Do not proceed with installation if there is water or moisture.
2. Remember that opening or removing the panels from the UPS you risk exposure to high and dangerous voltages.
3. Check there is no mains voltage on the equipment.
4. Check that the loads are off and disconnected from the UPS;
5. Check that the UPS is off and not live.

All the electrical connection operations are done working on the distribution box. The fuse carriers, output switch and manual bypass switch are on the outside of the box while inside you will find the terminal block on which to do the connections.

5.2.2 Preliminary operations

Before connecting the UPS make sure that:

1. Mains voltage (volt V in input) and frequency correspond to the values on the UPS rating plate;
2. Earthing complies with the IEC standards (International Electronic Commission) or local regulations;
3. The electrical system is equipped with all the necessary differential protections and thermal circuit breakers upstream from the UPS input.

5.2.3 Connecting the loads

Before actually starting to connect the loads make sure the rated power of the UPS (OUTPUT POWER) indicated on its rating plate is equivalent to or greater than the total sum of the load powers.

INDICATION

The loads wiring diagram is in the DIAGRAMS chapter.

The characteristics of the output cables must conform to the sections of the cables indicated in table 5 of the TABLES chapter

A separate switchboard must be supplied for the load. It is a good idea to use isolating switches or thermal circuit breakers conforming to the IEC standards to protect the lines leading from the electrical panel.

Use adhesive labels or some similar way to indicate the following values on the system's general panel:

- maximum rated power of the total load;
- maximum rated power of the load at power intakes;
- if an ordinary switchboard is used (outlets for mains voltage and for the UPS), make certain that there is an indication of the voltage applied on each outlet ("Mains" or "UPS").

5. Installation

5.2.4 Emergency Power Off (Remote E.P.O.)

In accordance with the standards, the UPS is fitted with an emergency device that uses a normally closed contact (already installed on the UPS) that can be opened to activate the emergency machine power off.

The E.P.O. terminals are in the UPS's rear panel on pins 3 and 4 of the 6-pole Combicon connector installed on contact interface.

To connect the emergency power off device please follow these instructions:

- Use a cable with double insulation, no more than 10 metres in length.
- Check that the switch used is galvanically insulated.

Electrical specifications of the E.P.O. interface:

- Voltage between terminals 3 and 4 (6P Combicon) with open circuit = 12Vdc.
- Current between terminals 3 and 4 (6P Combicon) with closed circuit = 5mA

The following figure shows how the emergency power off device has to be connected.

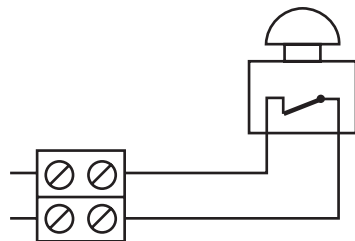

5.2.5 Installing the Trimod® BATTERY

It is possible to connect external battery units to increase ups autonomy.

If the configuration uses more than one battery it is necessary to position all the Trimod® Battery units on the same side of the UPS Trimod® and connect them in cascade with each other using the multicore cables supplied.

There are four different external battery cabinets for the Trimod® BATTERY units:

- a modular model consisting of a cabinet with an internal structure that uses battery drawers for up to a maximum of 80 12V 7.2Ah or 12V 9Ah batteries (16 drawers).
- a modular model consisting of a cabinet with an internal structure that uses battery boxes for up to a maximum of 100 12V 7.2Ah or 12V 9Ah batteries (20 drawers).
- a compact, non modular, economical model that uses a shelf architecture instead and on which the batteries are placed. It can house 60 or 120 12V 7.2Ah or 12V 9Ah batteries.
- a compact, non modular, economical model that uses a shelf architecture instead and on which the batteries are placed. It can house 20 12V 94Ah batteries.

A Trimod® BATTERY can be connected to several UPS Trimod® units.



WARNING

The following instructions are of a prescriptive nature and it is imperative they be complied with.

Opening or removing the panels from the UPS Trimod® or Trimod® BATTERY you risk exposure to high and dangerous voltages! To guarantee protection of personnel during installation of the Trimod® BATTERY make sure that the connections are done under the following conditions:

1. There must be no mains voltage
2. The loads are off and disconnected;
3. The UPS Trimod® is off with no voltage and all fuse carrier isolating switches on the UPS Trimod® and Trimod® BATTERY are open.

To ensure that the UPS Trimod® has stopped completely if you want to add a Trimod® BATTERY in an existing installation, follow the steps illustrated in the MAINTENANCE chapter.

The connection of a Trimod® BATTERY to the UPS Trimod® must be done according to the following diagram and the steps listed below:

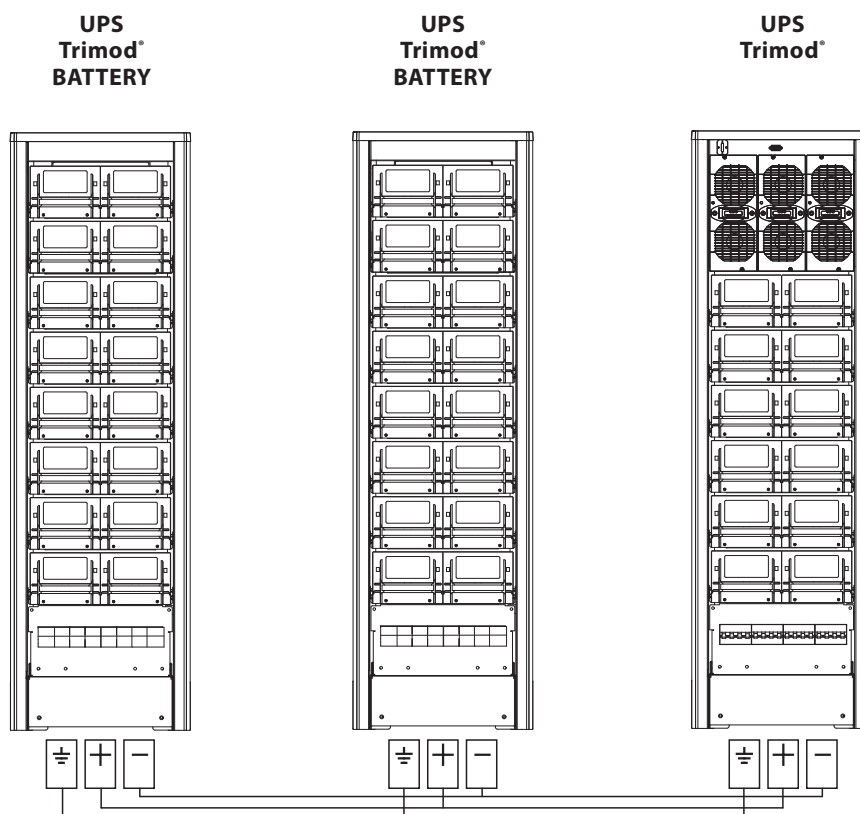

1. Make sure that all the battery fuse carrier isolating switches are open;
2. Connect the UPS and the additional battery cabinet using the earth cable (yellow-green);
3. Use the wiring supplied with the Trimod® BATTERY to connect the positive and negative terminals of the UPS Trimod® to those of the Trimod® BATTERY.

5. Installation

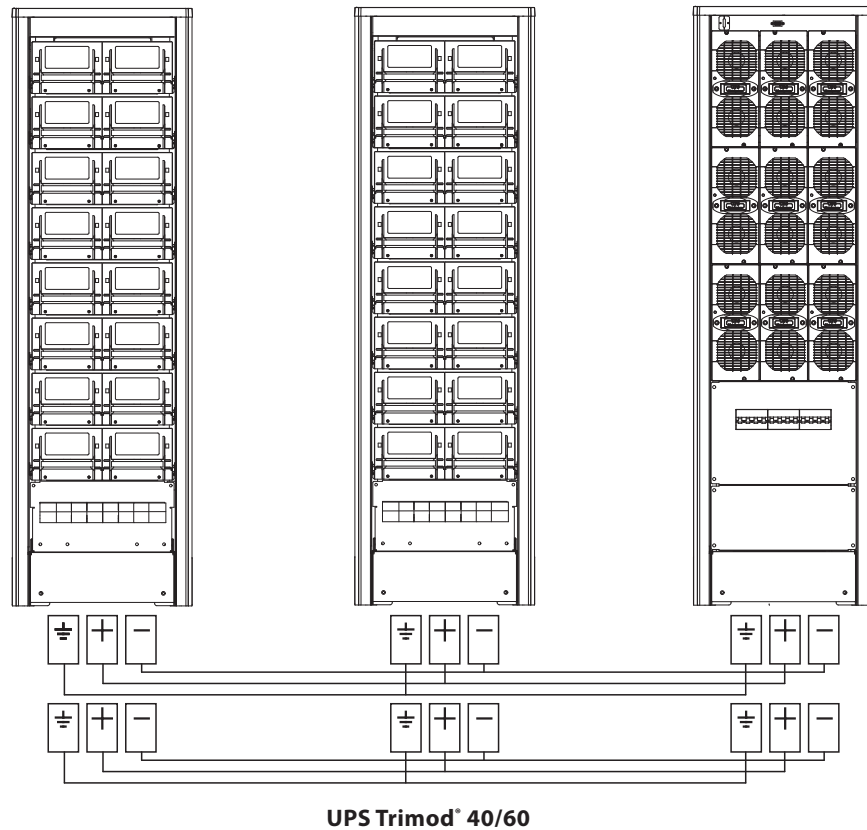

The connection of a Trimod® BATTERY to the UPS Trimod® 40 - 60 must be done according to the diagram above and the steps listed below:

1. Make sure that all the battery fuse carrier isolating switches are open;
2. In each Trimod® BATTERY remove the lower front panel;
3. In each Trimod® BATTERY remove the terminal block loosening the 2 securing screws;

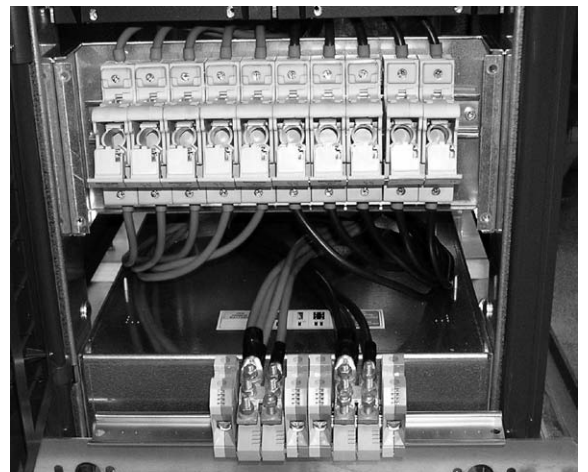
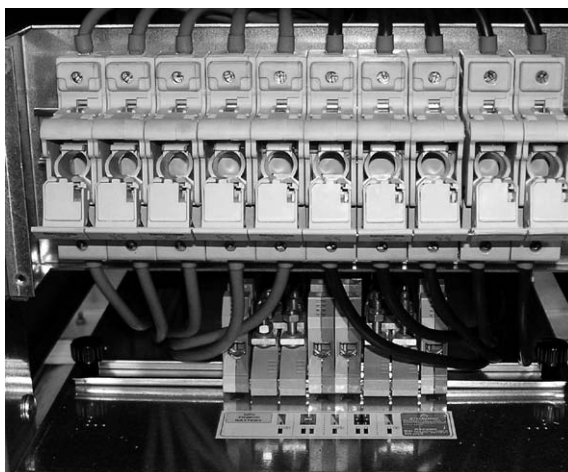

4. Connect the UPS and the additional battery cabinet using the earth cable (yellow-green);
5. Use the wirings supplied with the Trimod® BATTERY to connect the positive and negative terminals of the UPS Trimod® to those of the Trimod® BATTERY.



WARNING

The connection of a Trimod® BATTERY to the UPS Trimod® 40 must be done using BOTH wirings supplied with the Trimod® BATTERY.
The connection of a Trimod® BATTERY to the UPS Trimod® 60 must be done using BOTH wirings supplied with the Trimod® BATTERY.

6. In each Trimod® BATTERY insert the terminal block securing it with the 2 screws provided;
7. In each Trimod® BATTERY secure the lower front panel.

5.2.6 Protections

To ensure correct operation of the UPS and its accessories the electrical system must be adequately protected. Automatic differential switches and thermal circuit breakers are typically used, connected between the mains supply and the UPS with the purpose of providing additional protection in the event of overloads or short circuits.

INDICATION

Table 6, in the TABLES chapter, gives information about the thermal circuit breakers

5.2.7 Earthing

Connect the earth wire leading from the low voltage switchboard panel to the EARTH terminal on the UPS terminal block.

INDICATION

The wiring diagrams are given in the DIAGRAMS chapter

5.2.8 Connecting the power supply

For safety reasons, connection of the power supply must be the last thing to be done.

Before connecting the power supply cables with input make sure that the maintenance by-pass S1 is open in the OFF position and arrange fuses and jumpers on the terminal block according to the required input-output configuration.

INDICATION

Tables 1 to 8, in the TABLES chapter, gives information about sizing cables, fuses, circuit breakers and differentials.

The default configuration for the UPS Trimod® units distributed by LEGRAND® is a THREE-PHASE INPUT and a THREE-PHASE OUTPUT.

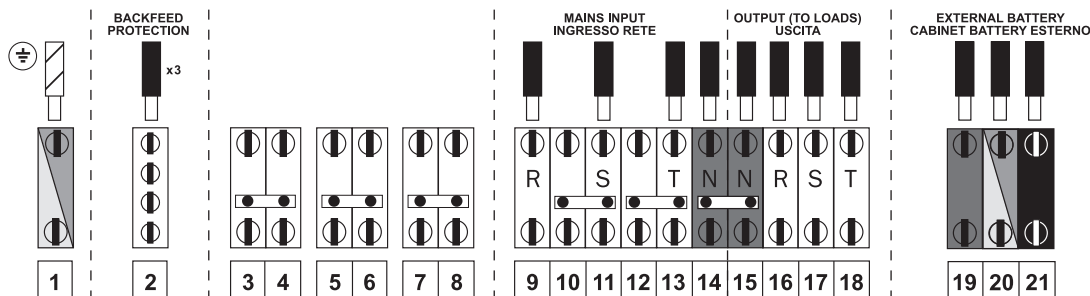

If you are using this type of distribution, the fuses and jumpers are already correctly sized and positioned. For different configurations please consult the following chapter and wiring diagrams in the 5.3 DIAGRAMS chapter. Connect the power cable leading from the low voltage switchboard to the UPS terminals as illustrated in the previous figure (or in the wiring diagram for the type of connection used), taking care to observe the cyclic direction of the phases (L1, L2 e L3).

5. Installation



WARNING

The neutral conductor cable in input must ALWAYS be connected! If the neutral is not connected the UPS could be seriously damaged when powered by the mains.

5.2.9 Wiring

The UPS has holes in the base for putting cables through if they are coming from underneath. It also has a pre-punched metal plate at the back arranged for inserting fairleads of different diameters.

The fairleads are supplied in the accessories kit.

The plate is fixed to the UPS with four screws.

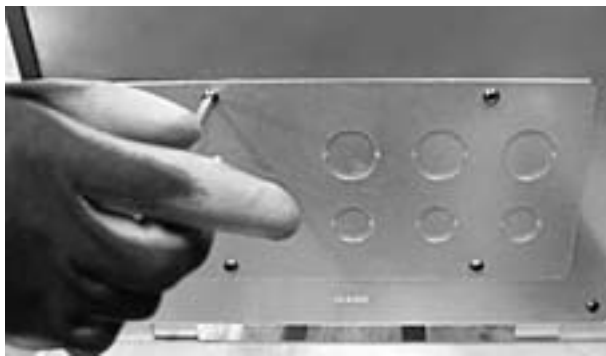

5.3 Wiring diagrams

The electrical configuration can be set up either on the operator panel or on the terminal block of the distribution box, located inside at the bottom of the front door. To access the distribution terminal block you have to loosen the box locking screws and pull it outwards.



WARNING

If the factory set configuration is changed (see paragraph 5.2.8) the new configuration must be set correctly via the instrument panel as described in paragraph 6.4.

5.3.1 Factory set configuration: THREE-PHASE input, THREE-PHASE output

The UPS is dispatched with the connections as per the following diagram. To use it with this configuration no interventions are required. We do however suggest that you check beforehand that the wiring in input, output and the connection of the modular terminals is correct.

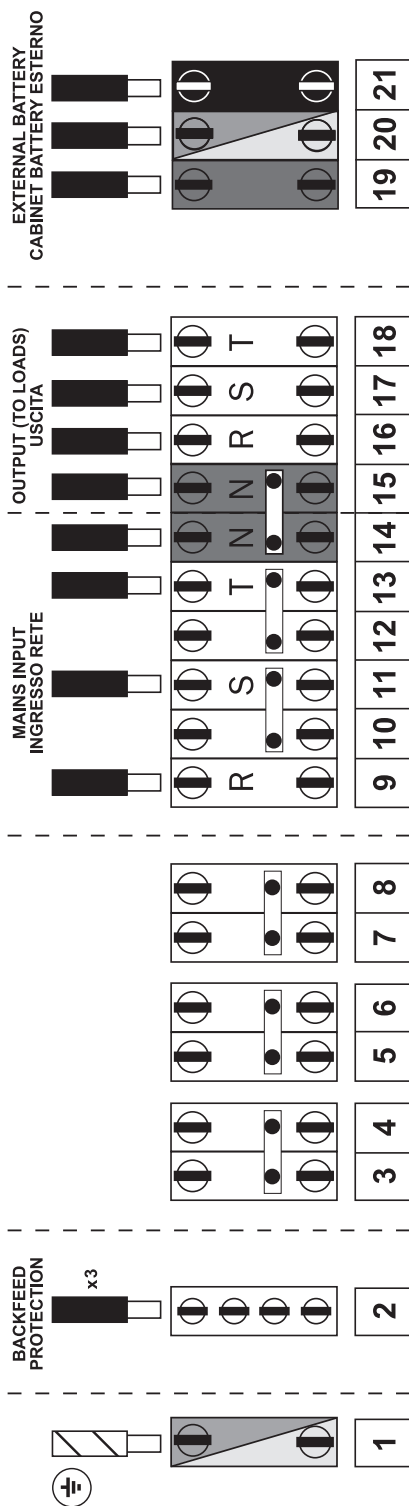

UPS Trimod® 10/15/20

5. Installation

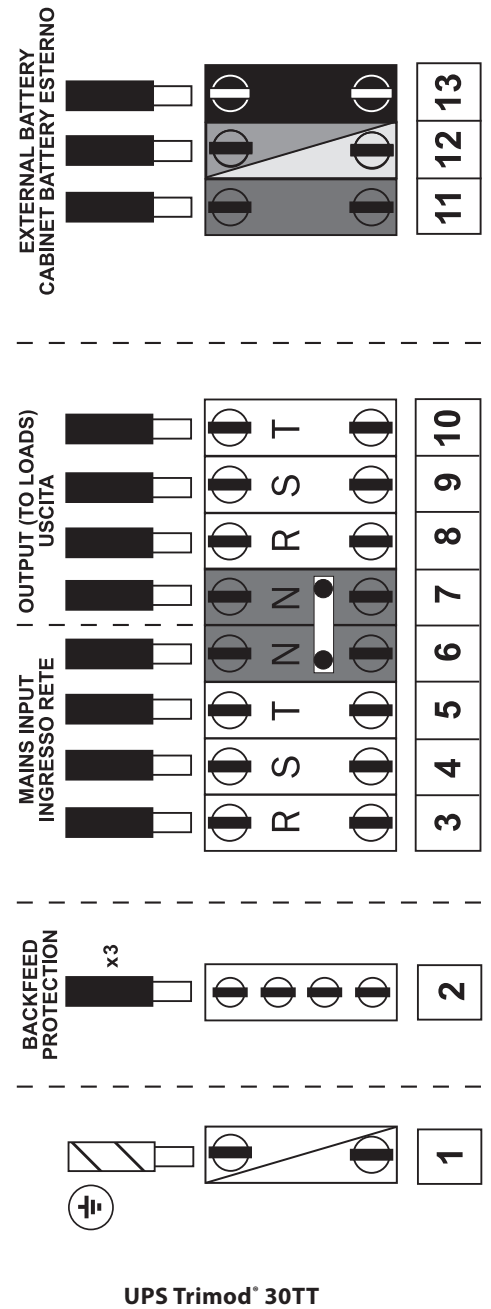
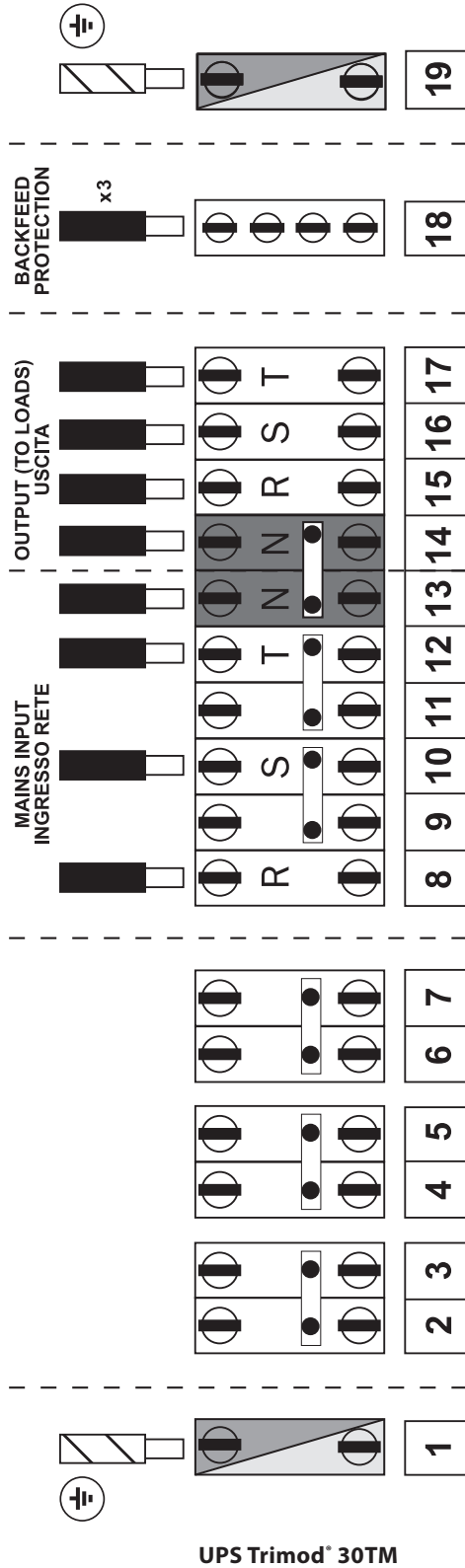

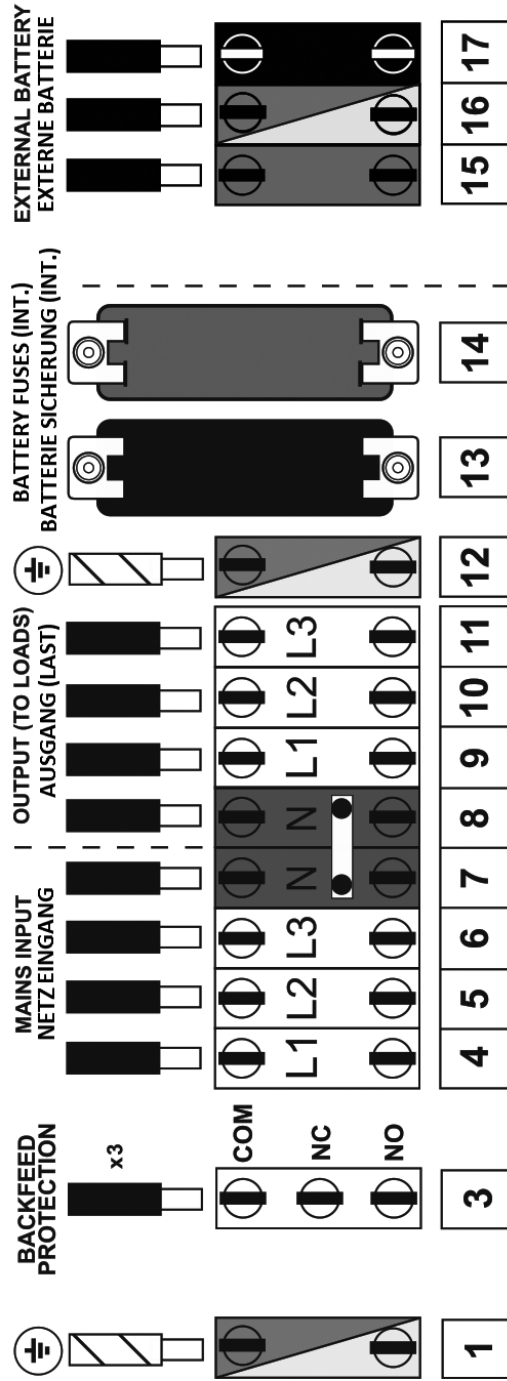

UPS Trimod® 30kVA with internal batteries

5. Installation

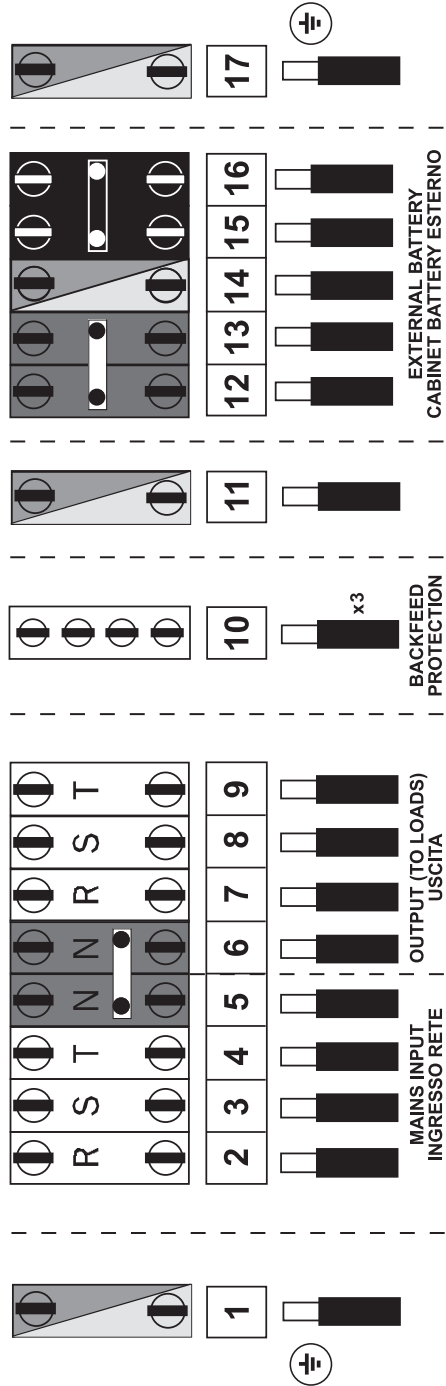

UPS Trimod[®] 40/60

5.3.2 THREE-PHASE input, SINGLE-PHASE output connection

For this type of connection, besides the wiring shown in the following figure, the software has to be configured via the instrument panel as illustrated in paragraph 6.4 STARTING PROCEDURE.

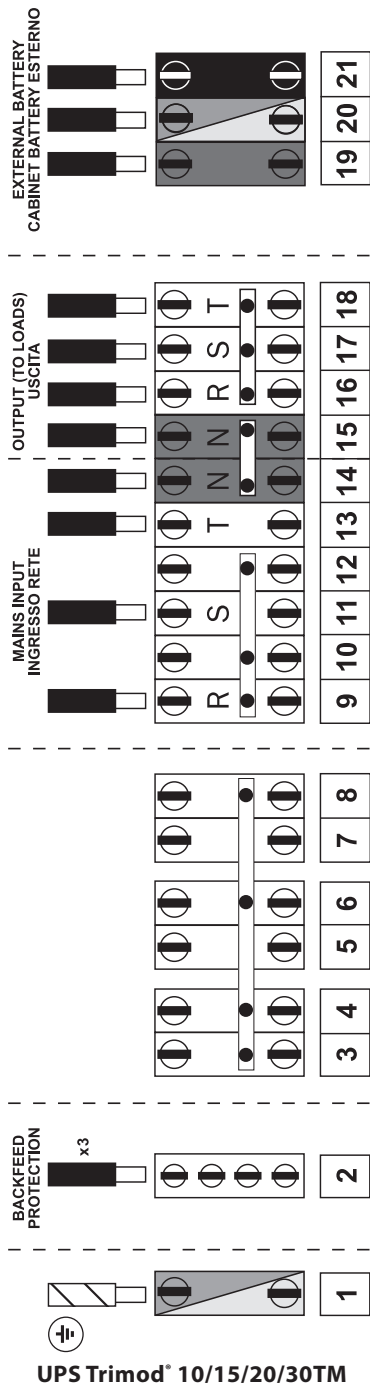

ATTENTION If the UPS is used with a single-phase output (available on 10/15/20/30TM models) you will have to plug in all the 'Back Panel' cards in the connector supplied in the accessory kit. The 'Back Panel' cards are located inside the machine behind the power modules. There is only one 'Back Panel' card in the Trimod® 10/15/20 models while in the Trimod® 30TM there are two. To access the 'Back Panel' cards and insert the connector, simply extract 3 power modules that are on the same shelf and refer to the following figure. The connector must be inserted in the position indicated with EC 15 on the card serigraphy. To extract the power modules please consult the MAINTENANCE chapter.

5. Installation

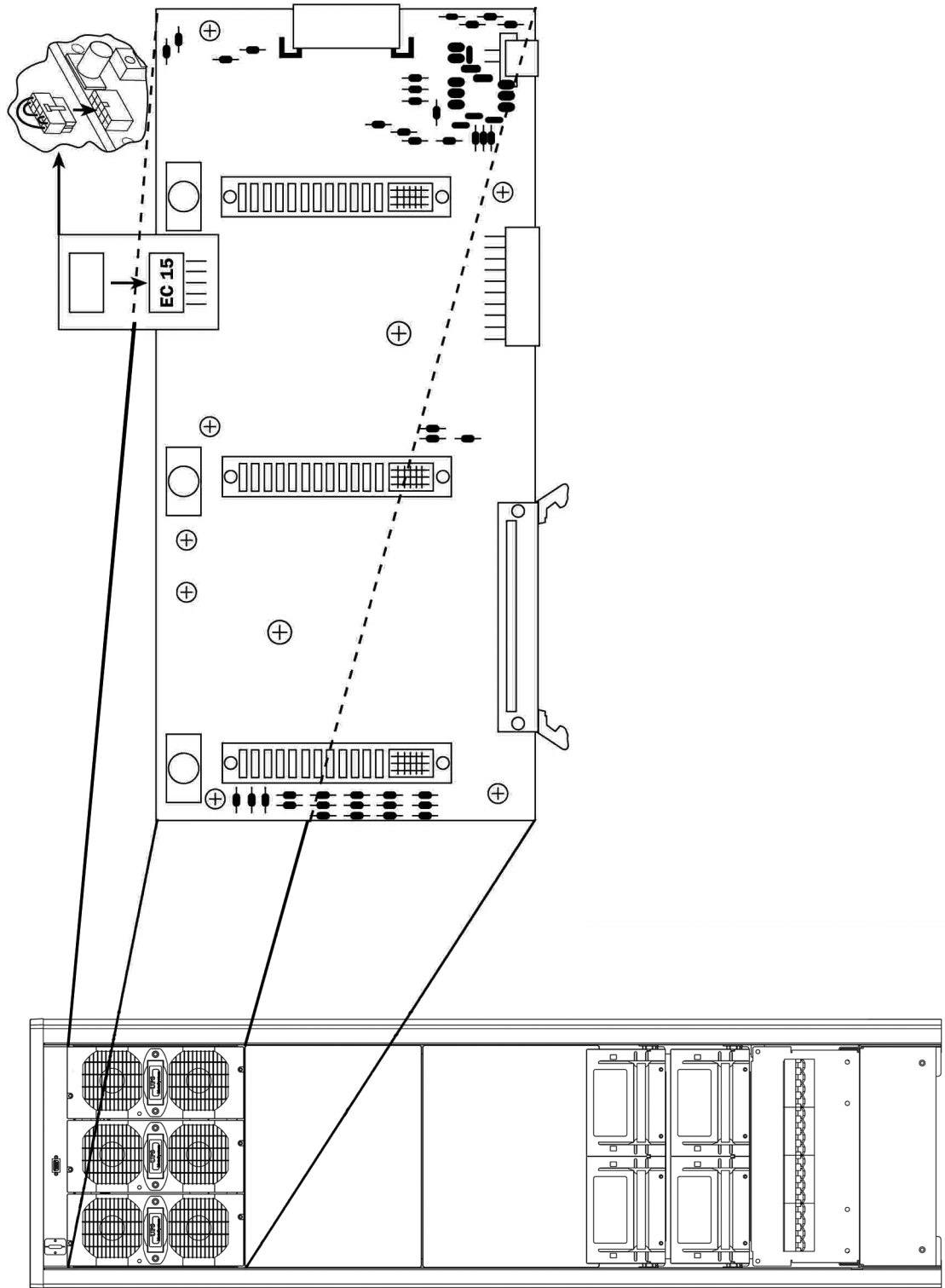

5.3.3 SINGLE-PHASE input, SINGLE-PHASE output connection

For this type of connection, besides the wiring shown in the following figure, the software has to be configured via the instrument panel as illustrated in paragraph 6.4 STARTING PROCEDURE.

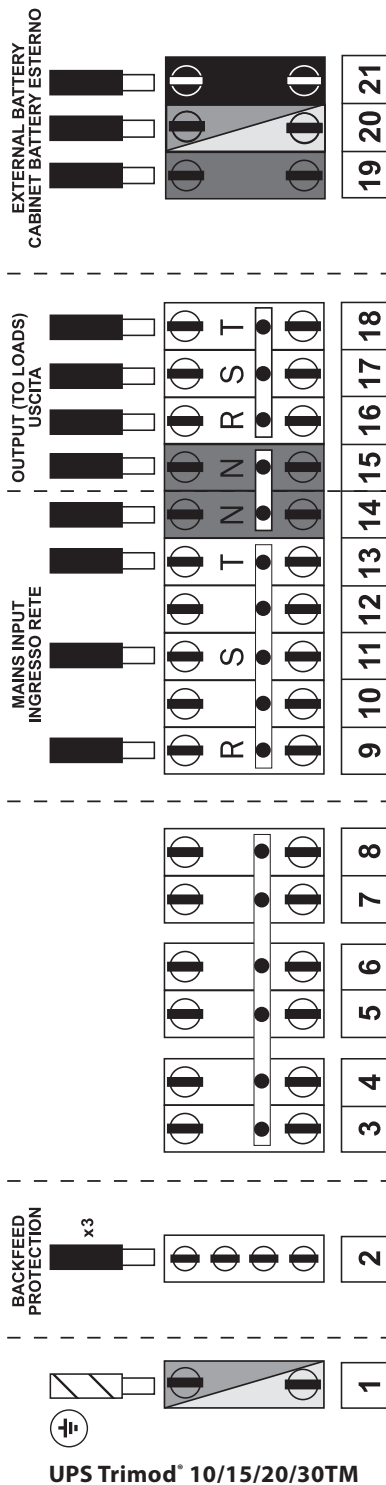

! ATTENTION If the UPS is used with a single-phase output (available on 10/15/20/30TM models) you will have to plug in all the 'Back Panel' cards in the connector supplied in the accessory kit. Follow the instructions given in the previous paragraph.

5. Installation

5.3.4 SINGLE-PHASE input, THREE-PHASE 120° output connection

For this type of connection, besides the wiring shown in the following figure, the software has to be configured via the instrument panel as illustrated in paragraph 6.4 STARTING PROCEDURE.

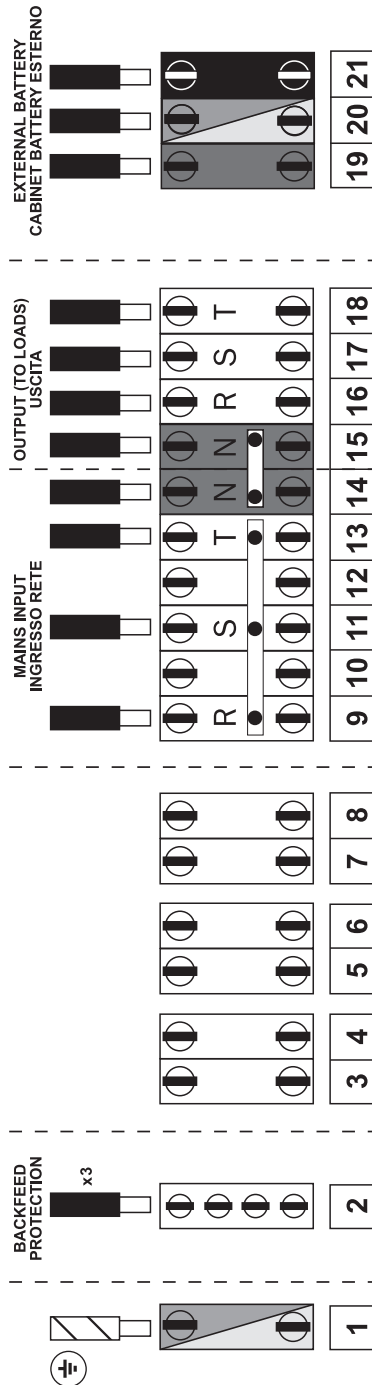

UPS Trimod® 10/15/20/30TM



WARNING

In the Trimod® models 10, 15, 20 and 30TM, in the case of a single-phase input and three-phase output configuration, the manual by-pass S1 **MUST NOT** be activated for any reason whatsoever. To this end the relative switch must be locked in the 'OFF' position. For greater safety it is possible to deactivate the by-pass completely by cutting the brown cable that connects the relative by-pass switch S1 to the MAINS INPUT fuse carrier isolating switch, isolating it. To the contrary, the cable connecting terminal 8 to the phase fuse carrier isolating switch **MUST** remain connected.

5.3.5 SINGLE-PHASE input connection, no. 3 separate outputs

For this type of connection, besides the wiring shown in the following figure, the software has to be configured via the instrument panel as illustrated in paragraph 6.4 STARTING PROCEDURE.

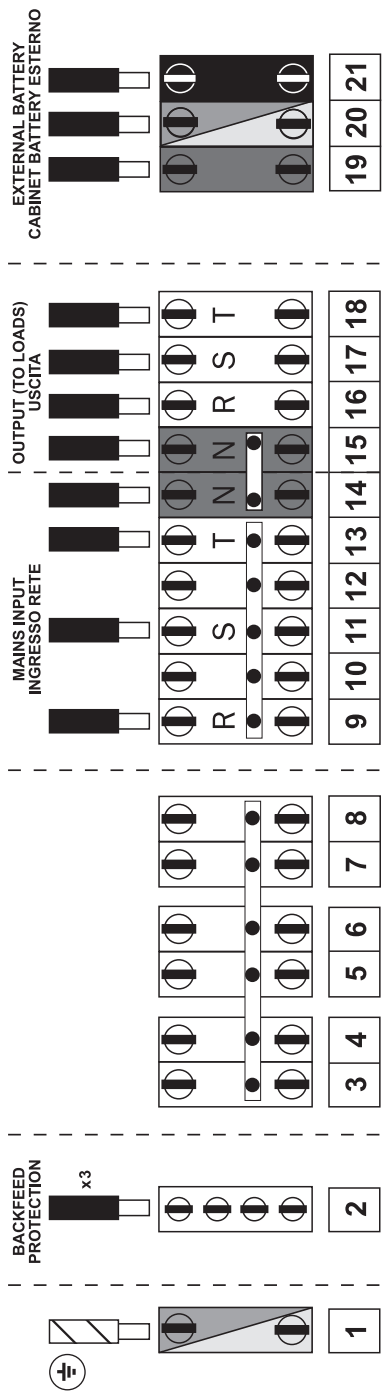

UPS Trimod® 10/15/20/30TM

5. Installation

Take from the packet of accessories one cross-connector and cut it in order to get the required length.

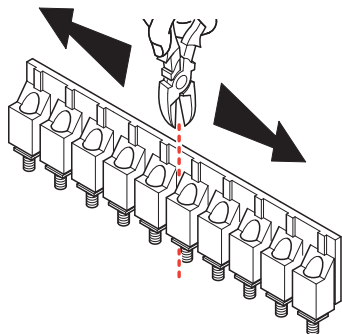

Insert the cross-connector into modular terminals as shown in connection blocks.

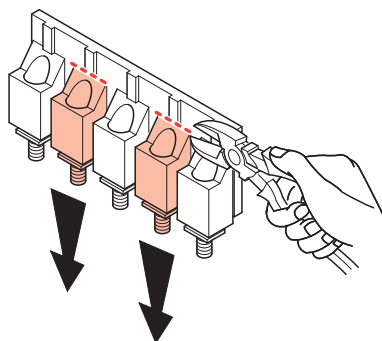

Insert the cross-connector into modular terminals as shown in connection blocks.

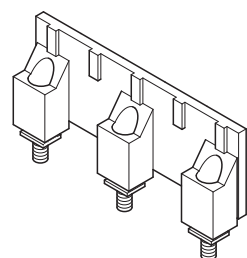

Secure the cross-connector to modular terminal with all the provided screws.

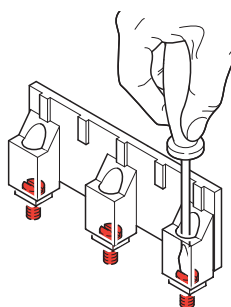

Screw all cross connectors

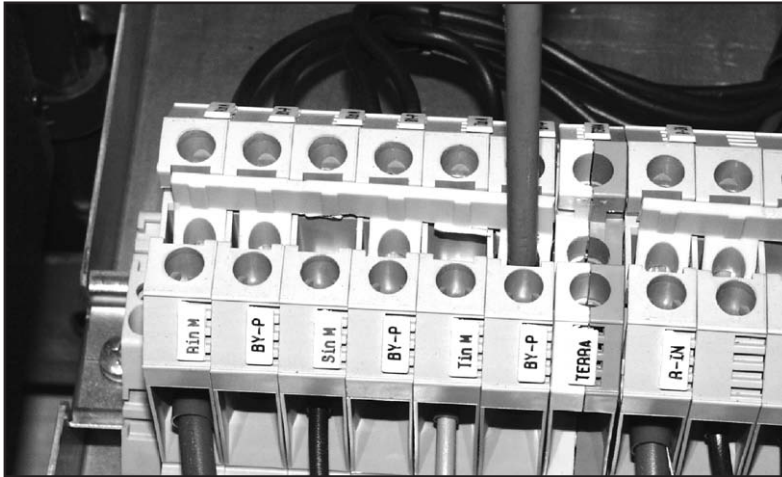

Remove the plastic cover

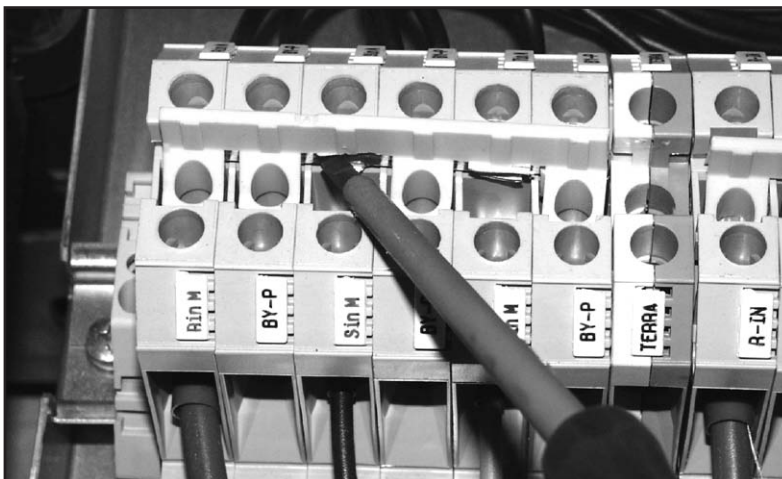

Check all cross connectors have been screwed properly

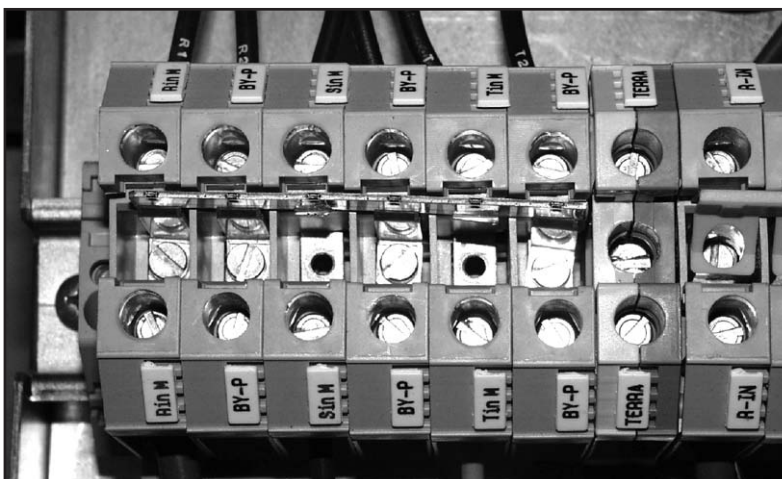

Insert the plastic cover

5. Installation

5.3.6 UPS Trimod® 30TM connections

To properly connect the UPS Trimod® 30TM it is necessary to remove both panels illustrated in the following figures.

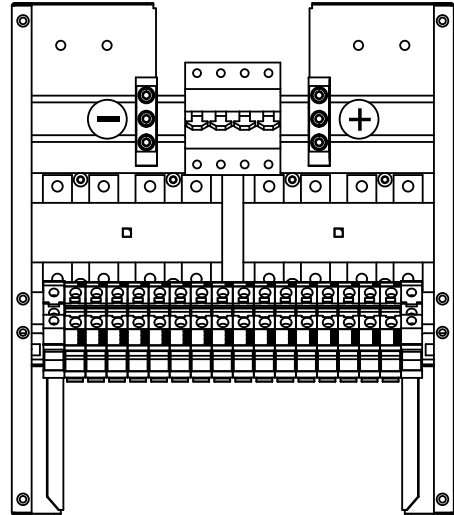
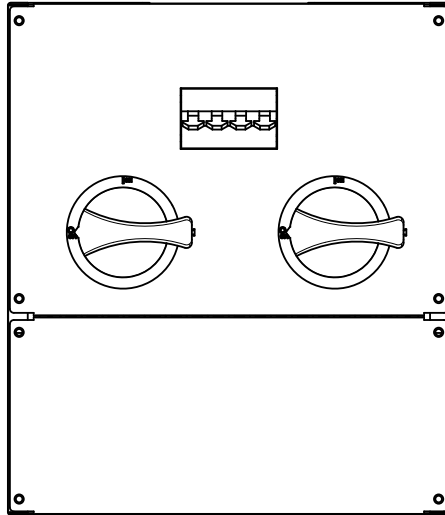

6. Configuration and Start-up



WARNING

The instructions given in this chapter are not for an ordinary operator but for a specialized, authorised technician only if he is using the Individual Protective Gear specified in chapter 3.

As illustrated in the previous chapter the default configuration for the Trimod® UPS units entails a THREE-PHASE INPUT and a THREE-PHASE OUTPUT. If this type of connection is used, the equipment requires no additional configuration as it has already been set in the factory.

On the other hand however, if the connection is changed please refer to the following instructions.

6.1 Input configuration

UPSTrimod® automatically recognises the voltage, frequency and number of phases in input even if the electrical connection on the terminal block is changed. So once the input wiring to the terminal block has been modified accordingly, no further configuration via the display is necessary.

6.2 Output configuration

The UPS Trimod® does not automatically recognise the electrical configuration on the output terminal block. Therefore, it is ALWAYS necessary to select the load type applied via the display.

The default configuration for the UPSTrimod® units is THREE 120° phases, 400 VAC. For powers of 10 to 30 kVA TM the unit can be configured to obtain just one single-phase output (230 VAC).

If the unit is configured with a three-phase output, it is possible to select management of the three phases as follows:

- THREE single-phase outputs: this setting is necessary if three separate single-phase lines were created at the UPS output. In this case, the UPS manages the three outputs separately one from the other.
For example, if an excessive load is applied to one of the three output lines, the bypass will intervene only on the overloaded line while power is guaranteed on the other two by the UPS.
- THREE 120° phases: this is the default setting and it is normally used if three-phase loads have been applied in output from the UPS (e.g. three-phase electrical motors) or if three-phase and single-phase loads are being powered by the UPS. In this case the UPS manages the three output phases, protecting the three-phase load.
For example, if an excessive load is applied to one of the three output lines, the automatic bypass switches all three output lines.

To select the system output configuration correctly on the display follow the instructions given in paragraph 6.4.

6.3 Checks prior to switching on

Check the following before powering the equipment:

1. Ensure that S3 input breaker is open;
2. Ensure that battery fuse breakers of the UPS (F B+ and F B-) and those of the Trimod® BATTERY (if used) are open;
3. Ensure that the input and output wiring is correct; check correct cycling of the phases in input;
4. Check that the mains input parameters (power voltage and frequency) are compatible with those specified on the UPS data plate.
5. Check that the maintenance by-pass switch S1 and the UPS output switch S2 are both in the OFF position.

6. Configuration and Start-up

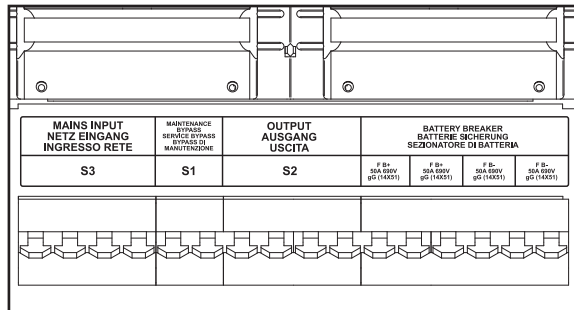

UPS Trimod® 10/15/20

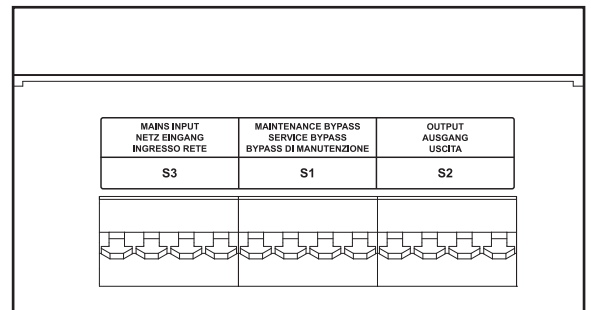

UPS Trimod® 30TT/40/60

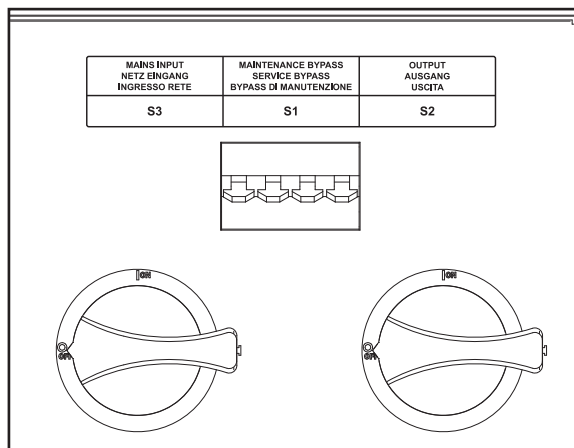

UPS Trimod® 30TM

6.4 Starting procedure

1. Insert the battery fuses in the relative isolating switches (F B+ and F B-) and, if applicable, those in the Trimod® BATTERY cabinets (if they exist).
2. Close UPS Trimod® and Trimod® BATTERY (if they exist) battery breakers.



WARNING

Before switching the unit ON the correct output configuration must be selected (Single-phase/Three-phase 120° / Three separate phases). To do this, proceed as follows.

3. With the unit off, press the ENTER key on the operator panel to gain access to the Service Mode. See the next chapter for more information about the SERVICE MODE and panel operation.
4. Follow this path: Config. UPS > Output > Inverter
Select Single-phase /Three-phase 120° / Three separate phases depending on the connection. Use the arrow keys to move the selection on the display, the Enter key to confirm, the ESC key to cancel.

Note: The configuration of the inverter output that is selected by display (three or single phase) must strictly correspond to the setup on the output terminals during installation.



WARNING

Wrong connections or output configuration settings can cause injury to people or damage to things!

5. Follow the path: Settings UPS -> Batteries -> Total KB
Check / select the correct number of KB (Battery Kit) installed.
6. Follow the path: Settings UPS -> Batteries -> Capacity
Check/select the correct value of KB battery capacity (Ah).
The KB value represents the total number of 20 batteries (installed in series) strings (installed in parallel).

Capacity in Ah to enter is the one of a single string (1KB).

UPS calculates the total capacity of the battery as a product of KB * Total Capacity.

7. Exit the Service Mode by pressing the ON/OFF pushbutton.
8. Provide power to the UPS input and close the switch network UPS;

**ATTENTION**

When the unit detects the input voltage it automatically proposes starting a battery charging cycle. Press the 'ESC' key to proceed to switching the UPS Trimod® ON.

9. Press the ON/OFF pushbutton the switch ON the UPS;
10. Wait until the status indicator on the display is solid green;
11. Verify that the values of voltage and frequency output set corresponds to the needs of the applied load. Otherwise enter the required values.
12. Close the output switch of the UPS.

At this stage the load is powered and protected by the UPS Trimod®.

**WARNING**

If, when installing, you think it is necessary to check that the battery-run UPS is working properly, turn the mains power voltage OFF by means of the switch breaker outside the UPS and NOT by means of the input breakers inside the UPS distribution drawer.

If the UPS has internal batteries it will instead be necessary to open at least one drawer for each set (one set consists of 4 boxes). This cuts the power voltage off to the terminal block generated by the various sets of batteries. This must be done for all sets.

Each drawer is fixed with two screws which must be removed beforehand.



Before programming the unit, make sure that all the modules (inverter and/or battery drawers) are closed and fixed with the screws.

Close the door and take the keys out.

7. Control Panel

The control panel, at the front of the unit, has a 4-line, 20-character LCD display, a backlit multicolour status indicator and a 5-key keypad.

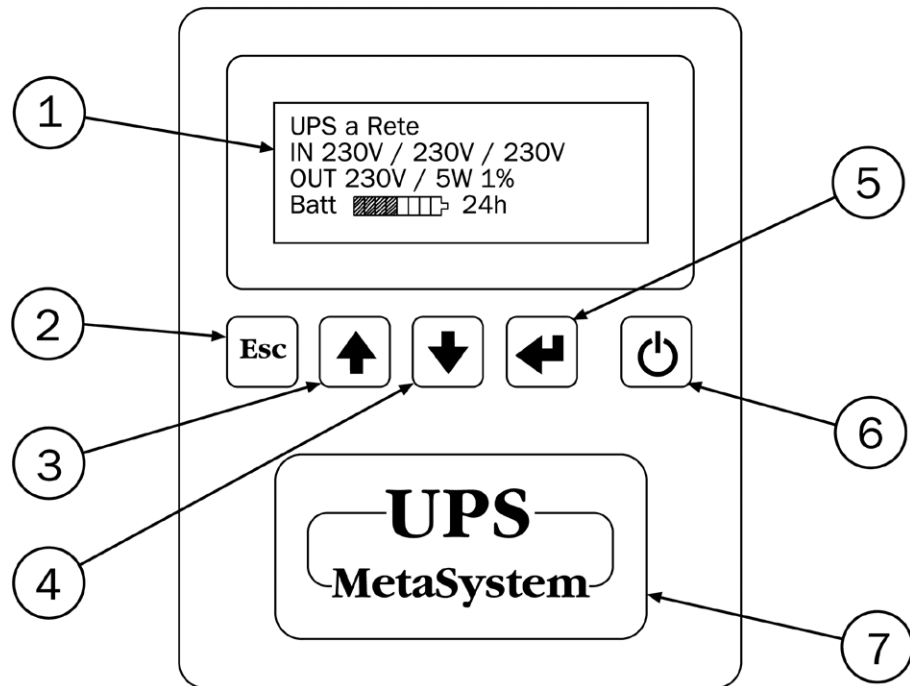

The keys on the front panel are used to gain access to the UPS menus.

Legend:

1 - 4 line x 20 character LCD display



2 - ESCAPE key

Main functions:

- Exit a function without modifying;
- Goes from a lower to a higher menu level;
- Exit the main menu and return to displaying status;
- Silencing the acoustic indicator;



3 - UP ARROW key

Main functions:

- Selects the previous function;
- Increases a value inside a function;
- Selects a new item inside a function (e.g. from ENABLED to DISABLED);
- Scrolls the menus that contain more than 4 lines;
- Changes the main frame page



4 - DOWN ARROW key

Main functions:

- Selects the next function;
- Reduces a value inside a function;
- Selects a new item inside a function (e.g. from ENABLED to DISABLED);
- Scrolls the menus that contain more than 4 lines;
- Changes the main frame page

**5 - ENTER key**

Main functions:

- Confirms a value;
- Accesses a menu item;
- Goes from a higher to a lower menu level;
- It starts the service mode on;

**6 - ON/OFF key**

Main functions:

- it allows starting and stopping the UPS. Keep pressed for at least 2 seconds to shut down;
- it allows the output phases to be turned off individually, only with the UPS set as 3 independent phases in output. Press for at least 0.5 sec;

7 - Multicolour backlit status indicator.**7.1 “Service Mode” function**

This is the mode in which the Trimod® UPS is to be used when setting up during installation and for managing software upgrades of commands and Power Modules.

To access this mode press “ENTER” with the UPS off; the display turns on and the navigation MENU can be surfed. One of the eight languages available can be chosen for the strings displayed: Italian, English, German, French, Russian, Spanish, Polish and Portuguese.

To exit this mode press the “ON/OFF” key otherwise, after 20 minutes without receiving any manual or serial commands, the UPS exits the function automatically and shuts down.

7.2 Main menu and Submenus

Press the ON/OFF  button to start the UPS and confirm with the ENTER key when prompted. At the end of the start-up procedure the main frame appears on the display.

Remember that when starting the voltage in output from the machine is present only when the UPS STARTUP bar reaches the end and the main frame appears.

The UP ARROW and DOWN ARROW buttons can be used to scroll the main frame pages, each one giving different information on UPS status.

Below is a list of the main pages:

1. Input – output – battery;
2. Input – percentage output – battery;
3. Bypass – output – battery;
4. Bypass – percentage output – battery;
5. Load available in output;
6. Measurements on the output;
7. Output line voltages;
8. Measurements on the input;
9. Bypass line voltages;
10. Battery status.

7. Control Panel

The images of the different main frame pages are given below.

MAIN PAGE	DATA DISPLAYED												
<p>1 Input – output – battery</p> <div style="border: 1px solid black; padding: 5px; width: fit-content; margin: 0 auto;"> <p style="text-align: center;">TRIMOD</p> <p>IN [^]230V/226V/227V</p> <p>OUT [^]230V 93W 0%</p> <p>Batt. ■■■■▬▬▬▬▶ 12h</p> </div>	<p>1st line: UPS operating status;</p> <p>2nd line: Input voltages;</p> <p>3rd line: Voltage set in output, active power absorbed by the load and total load applied percentage</p> <p>4th line: Bar showing residual battery capacity and actual time of operation in the case of a power failure.</p>												
<p>2 Input – percentage output – battery</p> <div style="border: 1px solid black; padding: 5px; width: fit-content; margin: 0 auto;"> <p style="text-align: center;">TRIMOD</p> <p>IN [^]230V/228V/227V</p> <p>OUT 0%/ 0%/ 0%</p> <p>Batt. ■■■■▬▬▬▬▶ 12h</p> </div>	<p>1st line: UPS operating status;</p> <p>2nd line: Input voltages;</p> <p>3rd line: Load percentage on the phases in output;</p> <p>4th line: Bar showing residual battery capacity and actual time of operation in the case of a power failure.</p>												
<p>3 Bypass – output – battery</p> <div style="border: 1px solid black; padding: 5px; width: fit-content; margin: 0 auto;"> <p style="text-align: center;">TRIMOD</p> <p>BYP [^]230V/231V/229V</p> <p>OUT [^]230V 95W 0%</p> <p>Batt. ■■■■▬▬▬▬▶ 12h</p> </div>	<p>1st line: UPS operating status;</p> <p>2nd line: Bypass voltages;</p> <p>3rd line: Voltage set in output, active power absorbed by the load and total load applied percentage</p> <p>4th line: Bar showing residual battery capacity and actual time of operation in the case of a power failure.</p>												
<p>4 Bypass – percentage output – battery</p> <div style="border: 1px solid black; padding: 5px; width: fit-content; margin: 0 auto;"> <p style="text-align: center;">TRIMOD</p> <p>BYP [^]232V/231V/229V</p> <p>OUT 0%/ 0%/ 0%</p> <p>Batt. ■■■■▬▬▬▬▶ 12h</p> </div>	<p>1st line: UPS operating status;</p> <p>2nd line: Bypass voltages;</p> <p>3rd line: Load percentage on the phases in output;</p> <p>4th line: Bar showing residual battery capacity and actual time of operation in the case of a power failure</p>												
<p>5 Load availability in output</p> <div style="border: 1px solid black; padding: 5px; width: fit-content; margin: 0 auto;"> <p style="text-align: center;">TRIMOD</p> <table style="width: 100%; border-collapse: collapse;"> <tr> <td>L1o</td> <td>0.4/</td> <td>40kVA</td> <td>1%</td> </tr> <tr> <td>L2o</td> <td>0.5/</td> <td>40kVA</td> <td>1%</td> </tr> <tr> <td>L3o</td> <td>0.5/</td> <td>40kVA</td> <td>1%</td> </tr> </table> </div>	L1o	0.4/	40kVA	1%	L2o	0.5/	40kVA	1%	L3o	0.5/	40kVA	1%	<p>1st line: UPS operating status;</p> <p>2nd line: Phase L1: power in kVA or Watt with respect to nominal power or current with respect to the nominal and relative percentage;</p> <p>3rd line: Phase L2: power in kVA or Watt with respect to nominal power or current with respect to the nominal and relative percentage;</p> <p>4th line: Phase L3: power in kVA or Watt with respect to nominal power or current with respect to the nominal and relative percentage</p>
L1o	0.4/	40kVA	1%										
L2o	0.5/	40kVA	1%										
L3o	0.5/	40kVA	1%										
<p>6 Measurements on the output</p> <div style="border: 1px solid black; padding: 5px; width: fit-content; margin: 0 auto;"> <p style="text-align: center;">TRIMOD</p> <table style="width: 100%; border-collapse: collapse;"> <tr> <td>L1o231V</td> <td>1.7A</td> <td>27W</td> </tr> <tr> <td>L2o229V</td> <td>1.6A</td> <td>31W</td> </tr> <tr> <td>L3o231V</td> <td>1.9A</td> <td>29W</td> </tr> </table> </div>	L1o231V	1.7A	27W	L2o229V	1.6A	31W	L3o231V	1.9A	29W	<p>1st line: UPS operating status;</p> <p>2nd line: Phase L1 in output: Voltage, current and active power;</p> <p>3rd line: Phase L2 in output: Voltage, current and active power;</p> <p>4th line: Phase L3 in output: Voltage, current and active power.</p>			
L1o231V	1.7A	27W											
L2o229V	1.6A	31W											
L3o231V	1.9A	29W											
<p>7 Output related voltages</p> <div style="border: 1px solid black; padding: 5px; width: fit-content; margin: 0 auto;"> <p style="text-align: center;">TRIMOD</p> <p>L1o-L2o Δ 400V</p> <p>L2o-L3o Δ 399V</p> <p>L3o-L1o Δ 396V</p> </div>	<p>1st line: UPS operating status;</p> <p>2nd line: output: line voltage between phases L1 and L2;</p> <p>3rd line: output: line voltage between phases L2 and L3;</p> <p>4th line: output: line voltage between phases L3 and L1</p>												

MAIN PAGE	DATA DISPLAYED												
<p>8 Measurements on the input</p> <table border="1" style="margin-left: auto; margin-right: auto;"> <thead> <tr> <th colspan="3" style="text-align: center;">TRIMOD</th> </tr> </thead> <tbody> <tr> <td>L1i229V</td> <td>3.4A</td> <td>408W</td> </tr> <tr> <td>L2i228V</td> <td>2.9A</td> <td>162W</td> </tr> <tr> <td>L3i230V</td> <td>2.6A</td> <td>228W</td> </tr> </tbody> </table>	TRIMOD			L1i229V	3.4A	408W	L2i228V	2.9A	162W	L3i230V	2.6A	228W	<p>1st line: UPS operating status; 2nd line: Phase L1 in input: Voltage, current and active power; 3rd line: Phase L2 in input: Voltage, current and active power; 4th line: Phase L3 in input: Voltage, current and active power.</p>
TRIMOD													
L1i229V	3.4A	408W											
L2i228V	2.9A	162W											
L3i230V	2.6A	228W											
<p>9 Bypass line voltages</p> <table border="1" style="margin-left: auto; margin-right: auto;"> <thead> <tr> <th colspan="2" style="text-align: center;">TRIMOD</th> </tr> </thead> <tbody> <tr> <td>L1b-L2b Δ</td> <td>401V</td> </tr> <tr> <td>L2b-L3b Δ</td> <td>402V</td> </tr> <tr> <td>L3b-L1b Δ</td> <td>400V</td> </tr> </tbody> </table>	TRIMOD		L1b-L2b Δ	401V	L2b-L3b Δ	402V	L3b-L1b Δ	400V	<p>1st line: UPS operating status; 2nd bypass line: line voltage between phases L1 and L2; 3rd bypass line: line voltage between phases L2 and L3; 4th bypass line: line voltage between phases L3 and L1.</p>				
TRIMOD													
L1b-L2b Δ	401V												
L2b-L3b Δ	402V												
L3b-L1b Δ	400V												
<p>10 Battery status</p> <table border="1" style="margin-left: auto; margin-right: auto;"> <thead> <tr> <th colspan="3" style="text-align: center;">TRIMOD</th> </tr> </thead> <tbody> <tr> <td>Batt.</td> <td>\wedge288V</td> <td>-0,3A</td> </tr> <tr> <td>C 50%</td> <td>R 12h</td> <td>T 24h</td> </tr> <tr> <td>In carica</td> <td colspan="2" style="text-align: center;">- mant.</td> </tr> </tbody> </table>	TRIMOD			Batt.	\wedge 288V	-0,3A	C 50%	R 12h	T 24h	In carica	- mant.		<p>1st line: UPS operating status; 2nd line: voltage, load current (negative value with ongoing load, positive value when the batteries are powering the machine); 3rd line: capacity percentage of the batteries with respect to the nominal, autonomy time left, total autonomy time; 4th line: battery status: - Batt. on Standby: Batteries on stand-by - Running down: Batteries running down - Autonomy reserve: Autonomy reserve: - End of autonomy: End of autonomy, UPS shutting down; - Charging - f1: battery charging status (current limitation); - Charging - f2: battery charging status (voltage limitation); - Charging - maint.: Battery charge in maintenance; - Batt. being tested Batteries being tested; - Battery Equal.batteries being equalised; - BATTERIES FAILED: batteries failed; - Max. Battery time Maximum time when the battery is flat, UPS shutting down;</p>
TRIMOD													
Batt.	\wedge 288V	-0,3A											
C 50%	R 12h	T 24h											
In carica	- mant.												

The keys on the front panel are used to gain access to the UPS menus.

INDICATION

Press the ENTER key on the main frame to gain access to the main menu which contains the following options:

- UPS STATUS: it allows checking of the UPS's functional status in real time;
- UPS SETTINGS: it allows configuration of all the UPS functions;
- POWER MODULES: it allows analysing of the status of each single power module in real time;
- EVENTS: it allows the visual display and/or deletion of stored events in the UPS log;
- TOOLS: it allows a series of functional tests to be run on the UPS.
- LOG OUT: it allows the session to be terminated by entering a password:

By selecting one of the above listed items again with "ENTER", you gain access to the relative submenu. The following table summarises them all.

7. Control Panel

UPS STATUS	UPS SETTINGS	POWER MODULES	EVENTS	TOOLS	LOG OUT (o)
UPS Info	Options	PM status	Visualization	Batteries	-
UPS config.	Output	Diagnostics (*)	Deletion	Signalling Test (*)	
Measurements	Input	PM SW update (*)		LCD Display Test (*)	
Alarms	Bypass			Support	
Historical Data	Batteries			Reset CM Errors	
	Operator Panel				
	Clock Setting				
	Contact Interface				

(*) Available in the "Service Mode" only

(o) Available with password protected session

The UPS has a menu structure with relative tree submenus, the functions of which are explained in the following paragraphs. An arrow facing down or up appears on the right of the display when there are other items to see. Use the arrow keys to see these items.

7.2.1 UPS status

UPS Info	Trimod® Model	Equipment model
	Synchr. address	Synchronisation address for this command
	CM number	Number of commands recognised
	Max VA	Maximum suppliable apparent power [kVA]
	Max W	Maximum suppliable active power [kW]
	Max I _{cgh}	Maximum current that can be supplied for charging the batteries [A]
	SW vers.	Firmware version of the control
	PM SW vers.	Firmware version of the power modules
	Boot Ver.	Bootloader version in the command
	S/N	UPS serial number

UPS config.	OUT	Single-phase/Three-phase 120°/3 indep. phases
	IN	Single-phase/Three-phase/inverse threephase/Undefined
	X/X -- X/X - X/X	X Power modules divided by phase controlled by the UPS
	BCM Installed	Number of BCM installed
	KBs installed	Number of KBs installed (1 KB = 4 battery boxes)
	Batt. Cap.	Capacity of the batteries installed in Ah
	No. Batt. per KB	Number of batteries in series in one KB

Measurements	Output X	Power	Active power supplied in output by the UPS on phase X [W]
		App.Pow.	Apparent power supplied in output from the UPS on phase X [VA]
		V rms	Effective voltage supplied in output from the UPS on phase X [V RMS]
		Line Vrms	Effective line voltage between the phases in output from the UPS [V RMS]
		I rms	Effective current supplied in output from the UPS on phase X [A RMS]
		Peak I Val.	Peak current supplied in output from the UPS on phase X [A]
		Frequency	Frequency of the sinusoid voltage in output from phase X [Hz]
		Crest I Factor	Crest factor on phase X
		Power Factor	Power factor of the load connected to the UPS on phase X
		Max W	Maximum active power suppliable by the UPS on phase X [W]
		Power	Active power supplied by the UPS on the X phase, expressed as a percentage in relation to the maximum active power the UPS can supply on the X phase [%]
		Max VA	Maximum apparent power suppliable by the UPS on phase X [W]
		Appar. Power	Apparent power supplied by the UPS on the X phase, expressed as a percentage in relation to the maximum apparent power the UPS can supply on the X phase [%]

Note: press "ENTER" to change the X value and consequently vary the phase of which you are reading the data.

7. Control Panel

Measurements	Input X	Power	Active power absorbed by the UPS by the mains on phase X [W]
		Appar. Power	Apparent power absorbed by the UPS by the mains on phase X [VA]
		Vrms	Effective voltage in input to the UPS on phase X [V RMS]
		Bypass Vrms	Effective voltage in input to the UPS on phase X, for the bypass line [V RMS]
		Linked Vrms	Effective line voltage between the phases in input to the UPS for the bypass line [V RMS]
		Irms	Effective current absorbed by the UPS by the mains on phase X [A RMS]
		Peak I Value	Peak current absorbed by the UPS by the mains on phase X [A]
		Frequency	Frequency of the voltage sinusoid in input to the UPS on phase X for the bypass line [Hz]
		Crest I Factor	Crest factor applied by the UPS to the mains on phase X
		Power Factor	Power factor applied by the UPS to the mains on phase

Note: press "ENTER" to change the X value and consequently vary the phase of which you are reading the data.

Measurements	Batteries	Voltage	Voltage measured at the ends of the batteries [V]
		Current	Current supplied by the batteries (negative if the batteries are being charged) [A]
		Residual Capac.	Battery charged status, expressed as a percentage [0-100%]
		Chg Status	Working status of the battery charger: - Batt. in Standby; - Running down; - Autonomy reserve; - End of autonomy; - Charging – f1; - Charging – f2; - Charging – maint.; - Batt. being tested; - Battery equalisation; - BATTERIES FAILED; - Max. Battery time;
		Tot autonomy	Total autonomy the UPS would have with batteries charged 100%
		Res. autonomy	Residual autonomy of the UPS
		End of aut V	Battery threshold voltage for end of autonomy [V]
		No. run downs	Total number of times the batteries have been completely run down
		Use	Total number of hours the UPS has been running on battery [h]
		Cal.	Day and time the last calibration was made; Factory setting if no calibration has been done yet
		No. Calibrations	Total Number of calibrations made

Measurements	Misc.	Internal Temp.	Temperature inside the UPS [°C]
		H.V. Bus Pos.	Voltage on the DC BUS positive [V]
		H.V. Bus neg.	Voltage on the DC BUS negative [V]

Alarms	Alarm Register. See chapter 8.
---------------	--------------------------------

Note: press the "ARROW UP" and "ARROW DOWN" keys to scroll the list of alarms.

Historical Data	UPS operation	Total time the UPS has been working
	With battery	Total time the UPS has been running on battery
	Battery charger Op.	Total time the battery charger has been working
	Tot. run downs	Total number of times the batteries have been completely run down
	Booster Int.	Total number of Booster interventions
	Bypass Int.	Total number of Bypass interventions
	Batt. Calibr.	Total number of battery Calibrations
	Battery ch.Cycles	Total number of battery charger cycles
	Batt.eq.cycles	Total number of battery equalisation cycles
	>80% load N	Total number of times the load has exceeded 80% of nominal load
	>80% load T	Total time the load has exceeded 80% of the nominal load
	>100% load N	Total number of times charging has exceeded 100% of nominal load
	>100% load T	Total time the load has exceeded 100% of the nominal load without the overload being signalled

7. Control Panel

7.2.2 UPS settings

Options	Startup with Battery	If enabled, it allows the UPS to be started when there is a power failure
	Restart	If enabled, it allows automatic restarts

Output	Voltage	It sets the output voltage value [V]	
	Frequency	It sets the output frequency value [Hz] - Rated Value: it allows the output frequency value to be set (50 or 60 [Hz]) regardless of the supply voltage frequency. - Automatic Select.: if enabled the UPS measures the input voltage frequency and synchronises the output to the same value. If disabled the UPS uses the Nominal Value as the setting.	
	Inverter (*)	It sets the output configuration and the load applied: - Single-phase: just one single-phase output - Three-phase 120°: three-phase output suitable for supplying three-phase loads (e.g. a motor) - Three separate phases: three single-phase output lines separate from each other	
	Phases at starting (**)	Phase L1	It allows to program for each output the starting configuration: - Always On: the phase is always on during starting; - Always Off: the phase is always off during starting; Last Status: phase restored to the state before shutdown
Phase L2			
Phase L3			

(*) Available in the "Service Mode" only

(**) Available only with 3 phase independent inverter



ATTENTION:

Please refer to paragraph 2.4 to set the CONFIG INVERTER parameter correctly.

Input	PLL enabling	If enabled, the UPS synchronises the output sinusoid with that of the input. If disabled, the output voltage is not synchronised with the input and is signalled by the flashing of the status indicator (green)
	PLL range	Allows you to select the frequency range in which the UPS synchronizes output voltage with input voltage: - NORMAL: UPS synchronizes to the frequency variations of $\pm 2\%$ of the nominal value; - EXTENDED: UPS synchronizes to the frequency variations of $\pm 14\%$ of the nominal value; - CUSTOM: set by user (see main menu);
	Extended PLL range	If enabled, the UPS synchronises the output voltage with the input for frequency variations of $\pm 14\%$ of the nominal value. If disabled, the UPS synchronises for variations of frequency of $\pm 2\%$.
	Input Dip Enabling	It allows to enable/disable input Dip function

° available when PLL range is set on CUSTOM option.

Note: the PLL function sees to it that the unit's output frequency is synchronised with the input frequency, guaranteeing that the passage for zero occurs at exactly the same time. Hence, if activated, even if the bypass triggers (e.g. due to an overload), the input-output synchronisation is always guaranteed.



ATTENTION

If the PLL function is disabled the automatic bypass function is disabled automatically as well. If the overload is prolonged the UPS switches off (see "Overload permitted" in the Technical Description chapter).

Bypass	Bypass Enabling	If enabled, the UPS controls triggering of the bypass automatically. If disabled, the UPS will never switch over to bypass and, therefore, in the case of a prolonged overload (see "Overloaded permitted" in Chap. Technical Description), or In the case of a failure and redundancy absence, the UPS switches off.
	Forced Mode	If enabled, the UPS activates the bypass permanently. In this case the load is not protected.
	DIP speed	It allows variation of the automatic bypass activation sensitivity (forced mode disabled) <ul style="list-style-type: none"> - SLOW: loads that are not sensitive to drops in voltage or microinterruptions but which provoke frequent current peaks. - STANDARD: normal uses. - FAST: loads sensitive to the microinterruptions
	Start with Bypass	If enabled, when the mains are switched on, the first load feeding by the UPS is via the bypass. If disabled, the load peak will be handled by the inverter, as happens when switching on with the battery.

Batteries	Threshold Values	Aut end warning	Setting the start time of the end of battery autonomy warning
		Max. Battery time	Setting the maximum time of the UPS running on battery [sec]. When this battery time is up the UPS shuts down. Set OFF to disable to function
	Battery Charger	Charge in Standby	If enabled, it enables battery charging with the UPS off
	Restart	Restart Enabling	Enables or disables restarting of the unit when mains power returns after the batteries have run down completely
		Minimum autonomy	Minimum percentage of autonomy to preserve
	Total KBs	Sets the total number of KBs installed (1 KB = 4 battery boxes) Necessary for the UPS to supply correct autonomy values on the basis of the load applied and for correct battery charging.	
	Capacity (*)	Sets the capacity value of the batteries in the UPS [Ah]	

(*) Available in the "Service Mode" only



ATTENTION

Set the total KB value and Capacity correctly for the batteries being used. If set incorrectly there is the danger of damaging the batteries.

7. Control Panel

Operator Panel	Language	Sets the display language
	Buzzer	Enables/disables all acoustic signals
	Keyboard Beep	Enables/disables the acoustic signalling when the keys are pressed
	Shutting down block (*)	If enabled a password is required to shut the UPS down.
	Display Backlighting	Sets display backlighting - Fixed: always lit - Timed: lighting turns off if the keyboard is not used for 1 minute - Disables: lighting always off
	Display Contrast	Sets display contrast
	Password change	Sets a password that prevents access to UPS settings
	Password level	The default setting is in the USER item

(*) Only available with the password chosen

Clock Setting	DD/MM/YY – HH:mm:SS	Set the date/time of the UPS. ENTER": selects the value to change; ARROWS": increases/reduces the value selected DD: day; MM: month; YY: year; HH: hour; mm: minutes; SS: seconds.
----------------------	---------------------	--

Contact Interface	Item 1	Function	It allows to set item function: - Mains/Battery; - Autonomy reserve; - Alarm; - Overload; - Bypass;
		Setting	It allows the setting of item - normally closed - normally open
	Item 2	Function	See item 1
		Setting	
	Item 3	Function	See item 1
		Setting	
	Item 4	Function	See item 1
		Setting	
	Item 5	Function	See item 1
		Setting	
All items	It allows the setting of all items - normally closed - normally open		

7.2.3 Power Modules

PM status	PM X Info	Mod	Model of power module X	
		SW Vers.	Firmware version inside the power module X	
		HW Vers.	Hardware version of the power module X	
		S/N	Serial number of the power module X	
		Max VA	Maximum apparent power suppliable by the power module X [VA]	
		Max W	Maximum active power suppliable by the power module X [W]	
		Max I _{cgh}	Maximum current suppliable by the battery charger of the power module X [A]	
	PM Measurements	Input X	Power	Active power absorbed by the mains by the power module X [W]
			Appar. Power	Apparent power absorbed by the mains by the power module X [VA]
			V _{rms}	Effective voltage in input to power module X [V RMS]
			Bypass V _{rms}	Effective voltage in input to the power module X for the bypass line [V RMS]
			Linked V _{rms}	Input line voltage to the power module X [V RMS]
			I _{rms}	Effective current absorbed by the power module X by the mains [A RMS]
			Peak I Value	Peak current absorbed by the power module X by the mains [A]
			Frequency	Frequency of the sinusoid voltage in input to the power module X [Hz] for the bypass line
			Crest I Factor	Crest factor applied by the power module X to the mains
			Power factor	Power factor applied by the power module X to the mains
		Output X	Power	Active power supplied by the power module X [W]
			Appar. Power	Apparent power supplied in output by the power module X [VA]
			V _{rms}	Effective voltage supplied in output by the power module X [V RMS]
			Linked V _{rms}	Line voltage in output by the power module X [V RMS]
			I _{rms}	Effective current supplied in output by the power module X [A RMS]
			Peak I Value	Peak current supplied in output by the power module X [A]
			Frequency	Frequency of the sinusoid voltage in output from the power module X [Hz]
			Crest Factor	Crest factor of the current in output from the power module X
			Power factor	Power factor in output from the power module X
			Max W	Maximum active power suppliable by the power module X [W]
Power	Active power supplied by the power module X, expressed as a percentage in relation to the maximum active power the power module X can supply [%]			
Max VA	Maximum apparent power suppliable by the power module X [W]			
App. Power	Apparent power supplied by the power module X, expressed as a percentage in relation to the maximum apparent power the power module X can supply [%]			

(continue)

7. Control Panel

(following)

PM status	Battery X	Voltage	Voltage measured at the ends of the batteries by the power module X [V]
		Current	Current required to the batteries from the power module X (negative if the batteries are being charged) [A]
		Batt. Charger	Status of the battery charger inside module X
	Misc. X	INV. dissip. Temp.	Temperature of the INV dissipater (Inverter) of the power module X [°C]
		BST dissip. Temp.	Temperature of the Booster /PFC dissipater of the power module X [°C]
		Fan speed	Fan speed expressed as a percentage of the power module X
		HV Bus pos.	Voltage on the DC BUS positive of the power module X [V]
		HV Bus neg.	Voltage on the DC BUS negative of the power module Xm [V]
	PM Historical Data X	Run Time	Total time working
		Batt. Time	Total time running on battery
		CarBatt. Time	Total time the battery charger has been working
		Bypass int.	Total number of Bypass interventions
		Battery int.	Total number of battery interventions
		Dumper int.	Total number of Dumper interventions
		T mains high	Total number of times the input mains voltage has exceeded the maximum value allowed by the power module
		No. Overheat.	Total number of overheatings
		No. Overloads	Total number of overloads
		No. HV Bus run	Total number of overvoltages on the Bus
		No. Out DC Level	Total number of continuous voltage presences in output from the PMs

INDICATION

Press ENTER to change the X value and consequently vary the power module from where you read data.

Diagnostics (*)	Reset PM Errors	Deletes the memory of errors found in the power module. Resets only resettable errors.
------------------------	-----------------	--

PM SW update (*)	Update all the PMs	It allows the sequential and automatic updating of the internal software of all the UPS power modules. Press "ENTER" to start the procedure. If the update is unnecessary the following message appears on the display: "PM SW versions updated!" Press "ESC" to exit the frame.
	Update a single PM	It allows the updating of the internal software of a single power module. Using the "ARROW" keys you select the module you wish to update ('PM00' indicates the module at the top on the left, going on to the last one at the bottom on the right). By pressing "ENTER" key a frame appears that gives a comparison between the software that is actually in the module selected and the software you are about to load. Press "ENTER" to start the update procedure. Once updated, the message "PM SW version updated!" appears on the display. Press "ESC" to exit the frame.

(*) Available in the "Service Mode" only

7.2.4 Events

Events	Visual display	All	Displays all the events
		Critical	Displays events that have generated critical alarms
		Warning	Displays events that have generated non critical alarms
		Info	Displays events that have generated simple information
	Deletion	All	Deletes all the events

7.2.5 Tools

Batteries	Battery test	Tests the batteries to check their condition and performance
	Batt. Calibration	Calibrates the batteries, measuring the run down curve. If the battery is changed, we recommend carrying out this cycle so that the UPS provides precise information about the charge status
	Battery cycle	Executes a Battery Test and battery equalisation to verify their status and performance and to maximise battery life

Signalling Test (*)	Tests the luminous signals. Press "ENTER" to carry out the test on the signals of the status indicator (green, orange and red) and the acoustic signals
----------------------------	---

LCD Display Test (*)	Tests the alphanumerical display. By pressing "ENTER" all the characters available on the alphanumerical display are shown.
-----------------------------	---

(*) Available in the "Service Mode" only.

Support	Display Code	Displays code to communicate to Technical Service
	Use Code	Insert code supplied by Technical Service

Reset CM Errors	Deletes the memory of errors found in command board
------------------------	---

7. Control Panel

7.2.6 Log Out

A password can be set to protect the UPS from changes to settings by unauthorised personnel. Choosing a password each time the UPS settings need changing is necessary to access a private session.

Use the "Log Out" menu to exit the private session when finished.

If you forget the password contact the assistance centre.

7.2.7 Turning the single output phases ON and OFF

When the inverter output is configured as three separate single-phase lines, by very lightly pressing the On/Off key for less than 500 ms it is possible to gain access to a particular menu where you can choose which of the three phases L1,L2,L3 to turn on or off independently from the others.

7.2.8 Shutting down the UPS Trimod®



ATTENTION

The shutting down procedure described below is to be used only and exclusively if the load applied to the UPS is off or does not need powering by it.

1. Check there is no need to power the connected loads.
2. Hold down the ON/OFF button on the UPS control panel for at least 2 seconds.
3. When asked "Turn the UPS off?" confirm with the ENTER key.
4. Wait for the shutdown operation to finish. If the UPS needs repairing or maintenance appertaining to the power modules, battery boxes or "black-panels"
5. Open the output switch.
6. Open the mains disconnecting switches
7. Open the battery disconnecting switches (F B+ and F B-) of the unit and of the Trimod® BATTERY system (if present).

If you expect to leave the UPS off for a long time, please read carefully and put into practice what is prescribed in paragraph 4.4 concerning storage.

If these operations are done correctly, there will be no voltage in the UPS Trimod®.

8. Diagnostics

8.1 Luminous and acoustic signals

The operating status indicator, on the front panel of the UPS, and the LED on the front of each power module, change colour depending on the actual operating status of the UPS or of them single power module, according to the following table:

INDICATION

Some luminous signals can be accompanied by an acoustic signal. Press the 'ESC' key to turn the acoustic signal off; each time it is pressed after this you will either enable or disable the acoustic signal.

STATUS INDICATOR	POWER MODULE LEDs	ACOUSTIC SIGNAL	MESSAGE ON THE DISPLAY	DESCRIPTION OF THE UPS STATUS AND OPERATING ADVICES
GREEN Fixed	GREEN Fixed	-	Trimod®	Normal operation with mains present and load within the limits
GREEN Fixed	GREEN Fixed	-	3V battery flat	Change the 3V command battery
GREEN Fixed ORANGE Intermittent	ORANGE Intermittent	-	Output/phase off	Phase turned off when configuring the 3 independent phases output
GREEN Fixed	1 module: ORANGE Fixed The remaining modules: GREEN Fixed	-	Battery equalisation	Batteries being equalised
GREEN Fast intermittent	GREEN Fast intermittent	-	-	There is no mains voltage and/or incorrect mains frequency on at least one module (>68Hz or <43Hz) and/or the input PLL is not synchronised.
GREEN Fast intermittent	-	-	-	No bypass, input PLL is not synchronised, bypass voltage outside the limits, incorrect or inverse bypass sequence, bypass frequency outside the tolerance
GREEN Fast intermittent	GREEN Fast intermittent	-	Bypass input KO	The bypass is unusable for supplying the load
ORANGE Fixed	GREEN Fast intermittent	-	UPS on Bypass	Operating in bypass automatic
ORANGE Fixed	ORANGE Fixed	On for 500 ms and off 12 s	UPS on Battery	Running on battery
ORANGE Fixed	ORANGE Fixed	-	Battery calibr.	Batteries being calibrated
ORANGE Fixed	-	-	Battery test	Batteries being tested
ORANGE Fast intermittent	GREEN Fixed	-	Maintenance required	Check the UPS periodically
ORANGE Fast intermittent	GREEN Fixed	-	Check the batteries	Check battery status
ORANGE Intermittent	ORANGE Fast intermittent	-	Forced bypass	Forced bypass mode

(continua)

8. Diagnostics

STATUS INDICATOR	POWER MODULE LEDs	ACOUSTIC SIGNAL	MESSAGE ON THE DISPLAY	DESCRIPTION OF THE UPS STATUS AND OPERATING ADVICES
ORANGE Intermittent	ORANGE Fast intermittent	-	Manual bypass	Manual bypass mode
ORANGE Short double blink with pause	ORANGE Fixed	Short double blink with pause	AUTONOMY RESERVE!	Autonomy reserve
RED Fast intermittent	RED Fast intermittent	Fast intermittent	BATTERY CHARGER FAILED	Battery charger failed on at least one module
RED Fast intermittent	RED Fast intermittent	Fast intermittent	MODULE FAILED	At least one module failed. Possible failures: inverter, Booster/PFC, communication between CM and PM, battery connection, network connection, HVBUS connection
RED Fast intermittent	-	Fast intermittent	BATTERIES K.O.	Batteries failed or not connected
RED Fast intermittent	RED Short double blink with pause	Fast intermittent	RUNAWAY BATTERIES	Excessive voltage on the batteries
RED Fast intermittent	RED Short double blink with pause	Fast intermittent	HVBUS RUNAWAY FAILURE	Excessive voltage on the high voltage DC buses
RED Fast intermittent	RED Fixed	Fast intermittent	DC OUT LEVEL FAILURE	Excessive DC level in output
RED Fast intermittent	RED Short double blink with pause only on the PM in alarm	Fast intermittent	OVERHEATING	One or more power modules are overheating
RED Fast intermittent	RED Short double blink with pause only on the PM in overload	Fast intermittent	OVERLOAD	Overload on one or more power modules
RED Fast intermittent	RED Fast intermittent	Fast intermittent	BACKFEED	BACKFEED Error Detected

8.2 Messages

In this paragraph the messages that appear on the unit's display are listed, also giving the most likely cause that could have generated them.

If you are unable to solve the problem then please contact the Technical Service.

FIRST LINE OF THE MAIN FRAME

MESSAGE	MEANING
BUZZER OFF	The buzzer is turned off.
SERVICE MODE	UPS in the Service Mode. All settings via the display, maintenance functions and updates are possible.
BATTERIES BEING CHARGED	The UPS is charging the batteries. The load is not fed.
MAINTENANCE REQUIRED	Have specialized personnel carry out the routine check on the UPS.
CHECK THE BATTERIES	Have specialized personnel check battery status.
3V BATTERY FLAT	The control board's 3V battery is flat.
OUTPUT/PHASE OFF	Phase or output off Configuration achieved via the display or subsequent to a UPS malfunction.
BACKUP IN STANDBY	UPS set as a backup and output off.
BYPASS INPUT KO	Bypass input KO; some problems have arisen on the Bypass line. It is not possible to feed the loads directly off the mains.
UPS IN BYPASS	UPS in Bypass. The load is not protected by the UPS in this configuration.
FORCED BYPASS	The UPS has entered the forced Bypass mode via configuration on the display. Load not protected by the UPS.
MANUAL BYPASS	The load is powered directly by the mains via a manual bypass. In this configuration the load is not protected by the UPS.
UPS OFF-LINE	The load is powered directly by the bypass line. The load is protected because if there is a power failure with the line it switches the load over to battery.
UPS ON BATTERY	UPS on battery. The cause for this configuration is a failure in the UPS feeding system or a mains power failure.
BATTERY CALIBRATION	The UPS is calibrating the batteries by means of a command on the display.
BATTERY TEST	The UPS is testing the batteries to check their status and that they are working properly.
BATTERY EQUALIS.	The UPS is equalising the batteries.
BATTERY TEST.	The UPS is testing the batteries to check their status and verify they are working properly.
REFERENCE MALFUNCTION	Synchronisation error between the commands.
AUTONOMY RESERVE!	Battery charge level is at minimum. The unit is about to shutdown.
BATTERIES KO	Batteries failed. Check their operation and replace them if necessary.
RUNAWAY BATTERIES	Battery voltage out of control. Either the batteries or battery charger are/is malfunctioning.
HVBUS RUNAWAY FAILURE	A failure with the UPS has caused a voltage level on the High Voltage Bus that is out of control.
OUT DC LEVEL FAILURE	A failure with the UPS has caused a DC voltage in output.
OVERHEATING	The temperature inside the UPS is out of the nominal range.
OVERLOAD	The total load is higher than the UPS's nominal power. The UPS switches to Bypass if there is voltage on the bypass line otherwise it shuts down.

8. Diagnostics

MESSAGE	MEANING
BIG OVERLOAD	The load in output has caused an excessive drop in the output voltage.
BATTERY CHARGER FAILED	The battery charger circuit of one or more Power Modules has failed. It must be either repaired or changed.
MODULE FAILED	One or more Power Modules have failed. They must be either repaired or changed.
LOAD OFF!	An excessive load (e.g. short circuit) has caused an excessive drop in the output voltage for too long a time or the load has been switched off due to a prolonged battery overload.
UPS IN EMERGENCY!	UPS in Emergency.
UPS STOPPED!	UPS has stopped.
Shutdown in progress...	The unit is shutting down because it was programmed by the user.
PM not updated!	The software of one or more Power Modules is not compatible with the command. Update the modules before starting the unit.

FRAMES DISPLAYED WHEN SHUTTING DOWN

MESSAGE	MEANING
First start-up: connect the mains!	The UPS has never been switched on. No mains supply. Start-up not allowed. Make sure the mains are present before starting up.
No mains! start-up not allowed	No mains supply. Start-up not allowed. To start the UPS on battery, select this configuration via the display.
Emergency Power Off!	The Emergency Power Off (EPO) is working, the EPO command has been given by a push button or a disconnecting switch on the input line was opened while the UPS was working.
Config. incomplete for start-up!	The UPS requires a complete start-up configuration. Ensure that the output configuration, bypass enable, KB number, number of batteries for KB and the output voltage have been entered correctly.
Three-phase circuit sequence incorrect!	Invalid three-phase input sequence. Check that the three-phase circuit has been connected correctly.
The pms' hw versions are incorrect	One or more Power Modules are not compatible with the UPS. Call assistance.
Start-up error!	An error occurred during start-up of the UPS.
Start-up interrupted	Start-up possible only by confirming. Start-up was not confirmed within 30 seconds.
UPS shut down by programming!	UPS shut down by programming.
Shutting down due to an incorrect configuration	An error occurred in configuration. UPS in shutting down. The number of Power Modules detected by the UPS is incorrect for the output configuration set.
Shutting down due to a wrong KBnumber "	An error occurred when configuring the KBs. Set the right KB number.
Shutting down due to end of autonomy	Battery charge level is too low, UPS in shutting down.
Maximum time on battery	The UPS has been running on battery for the maximum time set, UPS shutting down.
Load not fed.	Load feeding interrupted.
Feeding from the output	Error in starting up. Voltage present on the UPS output. Check connections.
Shutting down with H.V. buses loaded	The UPS did not shutdown correctly. Make sure the DC buses are discharged prior to carrying out any maintenance on the unit.
Current data saving error	Error in saving some of the UPS parameters.

8. Diagnostics

IMPORTANT EVENTS

MESSAGE	MEANING
Inverter failure	Failure occurred in the Inverter circuit.
Booster failure	Failure occurred in the Booster / PFC circuit.
Battery charger failure	Failure occurred in the Battery Charger circuit.
Overheating	Overheating. Check the UPS ventilation system.
Overload	Overload. Check the load level connected to the UPS.
Excessive voltage on the H.V. BUS	Anomalous high voltage on the DC BUS.
Excessive DC level in output	The DC (Direct Current) level in output is excessive.
Excessive battery voltage	Battery voltage too high.
Power module communication failure	Failure of the communication system with the Power Modules.
Emergency	Emergency.
Load not powered.	Power to the loads has been interrupted.
Abnormal shutting down	UPS shut down abnormally.
Shutting down due to an overload	UPS shut down due to an prolonged overload.
Shutting down due to an Emergency Power Off	UPS shut down due to an Emergency Power Off.
Batteries KO	Battery failure.
PM battery connection failure	Failure in the connection of the batteries to the Power Module. Check battery fuses and wiring.
PM mains connection failure	Failure in the connection of power to the Power Module. Check mains fuses and wiring.
PM HVBus connection failure	Failure in the HVBus connection with the Power Modules. Check the HVBus fuses inside the Power Modules.
BACKFEED	BACKFEED Error Detected.

SIGNALLING EVENTS

MESSAGE	MEANING
Shutting down due to end of autonomy	UPS shut down due to the end of autonomy.
Shutting down due to incorrect three-phase sequence	UPS shut down due to an incorrect three-phase sequence in input.
Batt.cal.interrupted	Battery calibration interrupted by user.
Maximum time on battery	Maximum time on battery.
Start-up error	Error in starting up.
Start-up authorised when there are ongoing alarms	UPS start-up authorised in the presence of alarms.
Startup authorised with a new config.	UPS start-up authorised with a new configuration. The number of Power Modules installed on the UPS has changed.
Shutting down due to incorrect configuration	UPS shutting down due to an incorrect configuration. The number of Power Modules detected by the UPS is incorrect for the output configuration set.
Power Module FW update	The Power Module Firmware updated.
Big overload	Big overload.
Feeding from the output	Voltage present on the UPS output. Check connections.
Shutting down with H.V. buses loaded	The UPS did not shutdown correctly. The UPS shutdown without discharging all the buses completely.
Maintenance required	Have specialized personnel carry out the routine check on the UPS.
Check the batteries	Have specialized personnel check the batteries.
Replace the batteries	Check battery status and replace them if necessary.

8. Diagnostics

INFORMATION EVENTS

MESSAGE	MEANING
Startup by user	UPS start-up by user.
Shutting down by user	UPS shut down by user.
Automatic startup:	Automatic UPS start-up.
Delayed shutting down	The UPS was shut down by programming a delayed shutdown.
Battery charger start in stand-by	The battery charger started in standby.
UPS on battery	UPS on battery.
UPS on mains	UPS on mains.
Output off	The output is off.
Battery test executed	Battery test completed successfully
Batteries calibrated	Batteries calibrated successfully
Forced bypass ON	The forced bypass mode has been enabled. The load is powered by force directly by the bypass. Load not protected.
Forced bypass OFF	The forced bypass mode has been disabled.
Maintenance bypass ON	The load is powered directly by the manual bypass disconnecter. Load not protected.
Maintenance bypass OFF	The load is not powered directly by the manual bypass disconnecter.
Erased Events List	Events list has been erased by user.

ALARMS

MESSAGE	MEANING
INVERTER FAILURE	Failure occurred in the Inverter circuit.
BOOSTER FAILURE	Failure occurred in the Booster /PFC circuit.
BATTERY CHARGER FAILURE	Failure occurred in the Battery Charger circuit.
OVERHEATING	Overheating. Check the UPS ventilation system.
OVERLOAD	Overload. Check the load level connected to the UPS.
HVBUS RUNAWAY	Anomalous high voltage on the DC BUS.
EXC. IN OUTPUT DC LEVEL	Excessive DC voltage in output.
EXCESS.BATTERY VOLTAGE	Battery voltage too high.
PM -> CM COMMUNICATION FAILED	Failure of the communication system with the Power Modules.
BATTERY CONNECTION FAILURE	Error in connecting the battery to the Power Module. Check the connection and the battery fuse inside the Power Module.
MAINS CONNECTION FAILURE	Error in connecting the mains to the Power Module. Check the connection and the mains fuse inside the Power Module.
H.V.BUS CONNECTION FAILURE	Error in connecting the D.C. Bus to the Power Module. Check the connection and the D.C. bus fuse inside the Power Module.
CM -> PM COMMUNICATION FAILURE	Failure of the communication system with the Power Modules.
OVERLOAD	Overload.
LOAD NOT PROTECTED	Load not protected by the UPS.
MAINTENANCE REQUIRED	Have specialized personnel carry out the routine check on the UPS.
CHECK THE BATTERIES	Have specialized personnel check the batteries.
BACKFEED	BACKFEED Error Detected.

9. Maintenance



WARNING

The instructions given in this chapter are not addressed to a normal operator but to a specialised technician, authorised to work only if he uses the Individual Protective Gear mentioned in Chapter 3.

9.1 Introduction

This chapter contains all the information necessary for a correct maintenance of the UPS Trimod® unit.

All the operations described in this section must be carried out by authorised technicians or qualified personnel. LEGRAND® is not liable for any injury to persons or damage to things caused by incorrect operations or activities if not carried out according to the instructions given in this manual, with particular reference to the safety rules and regulations that can be found in chapter 3.

To ensure optimum operation of the UPS Trimod® and continuous and effective protection of the load connected to it, the batteries must be checked every six months after the first year of the machine's life, via the battery calibration function (see par 7.2.5).

9.2 Preventive maintenance

The UPS does not contain parts subject to preventive maintenance by the end user. Therefore, with the exception of normal cleaning, all the user has to do is periodically check there are no alarms on the display and that both fans on each power module are working correctly.

If there are any problems contact the LEGRAND® assistance centre immediately.

9.3 Periodical checks

Correct operation of the UPS must be guaranteed by periodical maintenance inspections, essential for safeguarding the unit's operating life and reliability.



WARNING

The periodical checks entail operations inside the UPS where dangerous voltages are present. Only maintenance personnel, trained and authorised by LEGRAND® know all the parts of the UPS that are live with dangerous voltages and, therefore, authorised to work on them.

During a preventive maintenance inspection, the maintenance technician must check the following:

- there are no alarms;
- the list of any events stored;
- correct operation of the static and maintenance bypass;
- integrity of the electrical installation;
- flow of cooling air;
- condition of the batteries;
- characteristics of the load applied;
- conditions of the installation premises.

9.3.1 Preparing the UPS for maintenance. Forced bypass mode.



WARNING

It is strictly forbidden to change the power modules if first the following instructions have not been scrupulously complied with!

1. Open the door of the UPS Trimod®;
2. Enable the UPS forced bypass operation via the front display.

To do this, proceed as follows:

Config. UPS -> Bypass -> Forced Mode Config;

Enable the parameter.

In these conditions the power modules are excluded and the load is fed directly by the mains; sul pannello compare la scritta "Bypass forzato". When the unit is in the forced bypass mode, the wording UPS LEGRAND® on the front of the

- panel flashes quickly. Likewise, the LEDs on the various power modules also flash quickly.
3. Turn the manual switch (manual bypass) to the ON position. The load is now being powered directly by the mains. The wording MANUAL BYPASS appears on the panel.
 4. Turn the output switch to the OFF position;
 5. Turn the unit off, holding the 'ON/OFF' pushbutton down on the control panel for a few seconds;
 6. Confirm UPS shutdown holding the ENTER pushbutton when required.
 7. Turn the mains switch to the OFF position;
 8. Open the battery disconnecting switches (F B+ and F B-) of the unit and of the Trimod® BATTERY units (if present);
 9. Hold the "ON/OFF" pushbutton down on the control panel in order to discharge internal capacities

Then proceed with the maintenance of UPS.



WARNING

Within the equipment there are dangerous parts due to the internal batteries even if you open up all the battery fuse breakers. To remove the tension due to the batteries, remove at least 1 drawer batteries for each shelf batteries present (in this way the series string of batteries is stopped).

9.4 Adding or replacing a power module or battery boxes

9.4.1 Power module

1. Make sure that the procedure described in the previous paragraph has been scrupulously applied.
2. Extract the module after having loosened the two securing screws.



WARNING

There are two holes on the body of the module, inside which two LEDs are housed which signal the presence of voltage on the connection terminals. MAKE ABSOLUTELY CERTAIN THAT THESE LEDs ARE OFF before handling the module. If they are on, wait until they have turned off.

3. Verify that on the new power module the two LEDs visible through the holes are both OFF. If ON, wait for them to go OFF.
4. Put the new power module in the same place of the old one or in one of the available compartments if you wish to increase UPS power.
5. Secure the power module to the unit's frame with the 2 screws provided.
The two screws also serve as grounding of the module, and therefore for safety purposes must be both fixed.

The procedure described needs no further manual settings via the operator panel, the UPS automatically recognises the new power module and reconfigures automatically.

As far as identification of the modules is concerned, bear in mind that the first module at the top on the left (in the previous figure it is the one being put in place) is always identified with number zero.

The adjacent module is, therefore, number 1. And the others follow.

9.4.2 Exit from the maintenance manual bypass

To restart the UPS maintenance bypass state to the on-line, follow the following guidelines:

1. Make sure the switch output is open,
2. Close battery breakers (FB + and FB-) UPS and all Trimod® BATTERY (if any);
3. Close mains breaker;
4. Turn on the UPS by pressing the ON / OFF.
5. Confirm the power up by pressing the ENTER pushbutton.
6. Wait until the UPS is fully turned on and is the main screen. Under these conditions the UPS and the load and on but in bypass mode; panel shows "Manual Bypass". In this state, this indicator was lit on the front panel takes on the color orange.
7. Close the output to the ON position.
8. Open the manual bypass switch to position OFF maintenance, the UPS automatically switches to the On-line.
9. After the procedure, and the load powered by UPS. In this state, this indicator was lit on the front panel takes on the color green.
10. Close the door of UPS Trimod®.

9. Maintenance

9.4.3 Battery Drawers

There are two different procedures for installing/replacing battery drawers inside UPS Trimod® and UPS BATTERY Trimod®. Carefully read all instructions before operating on the equipment.



WARNING

A battery can be a potential electric shock risk and a high short circuit current. The following precautions must be taken when working on the batteries:

- a) take off wristwatches, rings and any other metal objects;
- b) use tools that have a insulated handle/grip;
- c) wear rubber shoes and gloves;
- d) do not put tools or metal objects on top of the batteries;
- e) disconnect the charging source before connecting or disconnecting the battery terminals
- f) make sure the battery has not been accidentally connected to ground. If it has, disconnect the ground source.

If any part of a grounded battery is touched it can give an electric shock. Chances can be reduced if the ground connections are interrupted during installation and maintenance (applicable to battery power supplies and equipment placed far away and with no grounded power supply circuitry).

The drawers batteries must always be added/replaced in multiples of 4 (1 KB).

Note: if the installation/replacement has changed the total number of KB installed in the UPS, you must update the number of KB via the front panel. After completing the procedure above described, we recommend to calibrate batteries in order to get correct informations about UPS runtime.

If the UPS has more than 1 KB for each 10kVA output power, you can replace 1 KB at a time with UPS Online.

This operation can be done inside UPS Trimod® and/or UPS BATTERY Trimod®.

Remember that 1 KB consists of 4 battery drawers.

The replacement procedure is as follows:

1. Make sure the UPS has installed at least every 1KB 10kVA output power output plus one;
2. Make sure the UPS is not operating on battery and the charger is maintenance or standby state. To check the status of the charger, enter the state ups -> Measures -> batteries, and check the fourth item shown on the display.
3. Remove the four battery drawers (n° 1KB).
4. Insert the new 4 batteries drawers and secure them with the screws provided;
5. Repeat steps 2, 3 and 4 for each KB to install/replace.

In the case of simple addition of KB is enough to follow the steps 2, 4 and 5.



WARNING

Always replace only 1 KB at a time

Note: If the UPS switches to battery while you are performing the operation, stop and do not remove or insert battery drawers! it is possible to resume operation when the UPS returns to work on-line.

Note: if during the operation mains is missing, you will have a reduced autonomy: you should therefore carefully consider such cases in relation to the application before starting.

Installation / replacement battery drawers in UPS maintenance bypass

This procedure applies to each model of UPS Trimod® and UPS BATTERY Trimod®.



WARNING

In maintenance bypass the load is powered directly from the mains input.

1. To bring the UPS in maintenance bypass mode follow steps 1 to 8 described in paragraph 9.3.1.
2. Remove the four battery drawers (n° 1KB).
To add another KB (if there is enough space available) does not remove any battery drawer;
3. Insert the new four batteries drawers and secure with the screws provided;
4. Repeat steps 2 and 3 for each KB to install / replace.
5. Follow steps 1 to 6 described in section 9.4.2 to bring state of the UPS maintenance bypass switch to the On-line.

In the case of simple addition of KB is sufficient to perform the steps described in paragraphs 1, 3, 4 and 5.

10. Dismantling

**ATTENTION**

The instructions in this chapter are to be considered indicative. Please refer to the laws in the country where the unit is used.

10.1 Disposing of the batteries

At the end of their life, the batteries must be disposed of in a place set aside for the collection of such waste. Since batteries are toxic waste it is not allowed to dispose of them like traditional waste. For the correct procedure please contact the relevant Authorities in your area.

10.2 Dismantling the UPS

Once the batteries have been removed all the parts of the UPS Trimod® must be removed.

To remove and dismantle the unit wear the Individual Protective Gear described in chapter 3 and refer to the instructions and charts that you will find in this manual.

Once the various parts have been removed, divide the components into groups, separating metal from plastic, from copper, etc., according to the selected disposal scheme used in the country where the unit is being dismantled.

If the parts have to be stored while waiting to go to the dump, keep them in a safe place, protected from atmospheric agents to prevent any chance of contamination of the ground and under water tables (especially with lead and the electrolyte of the batteries).

10.3 Disposing of the electronic components

To dispose of these components, like, for example, the unit's control panel, refer to the laws relevant to this sector.

11. Tables

ATTENTION  the type and cross section of the connecting cables must be chosen according to their operating current and laying must be as established by existing laws; this is the responsibility of the installer. The UPS input current and output power are given in paragraph 2.4 and the battery current in Table 8.

WARNING  The following tables give only an indication of the cable cross sections to use as far as concerns using unipolar cables, with single insulation, in PVC and laid in a pipe above ground.

TABLE 1
Minimal Recommended Cable Sections for UPS Trimod®

POWER	INPUT PHASES	OUTPUT PHASES	INPUT CABLE	OUTPUT CABLE
10 kVA	3	3	5 x (4 mm ²)	5 x (4 mm ²)
	1	1	3 x (10 mm ²)	3 x (10 mm ²)
	1	3	3 x (10 mm ²)	5 x (4 mm ²)
	3	1	5 x (10 mm ²)	3 x (10 mm ²)
15/20 kVA	3	3	5 x (10 mm ²)	5 x (10 mm ²)
	1	1	3 x (25 mm ²)	3 x (25 mm ²)
	1	3	3 x (25 mm ²)	5 x (10 mm ²)
	3	1	5 x (25 mm ²)	3 x (25 mm ²)
30 kVA TM	3	3	5 x (16 mm ²)	5 x (16 mm ²)
	1	1	3 x (50 mm ²)	3 x (50 mm ²)
	1	3	3 x (50 mm ²)	5 x (16 mm ²)
	3	1	5 x (50 mm ²)	3 x (50 mm ²)
30 kVA TT	3	3	5 x (16 mm ²)	5 x (16 mm ²)
40 kVA	3	3	5 x (25 mm ²)	5 x (25 mm ²)
60 kVA	3	3	5 x (35 mm ²)	5 x (35 mm ²)

TABLE 2
UPS Trimod® Recommended Battery Fuse Ratings

POWER	BATTERY FUSE	
	UPS Trimod®	
	F B+	F B-
10/15/20 kVA	50A 500V gG (14 x 51 mm)	50A 500V gG (14 x 51 mm)
30 kVA	160A 500V gG (SIZE 00)	160A 500V gG (SIZE 00)

TABLE 3
UPS Trimod® BATTERY Recommended Battery Fuse Ratings

POWER	BATTERY FUSE	
	Trimod® BATTERY 4KB	
	F B+	F B-
10/15/20/30/40/60 kVA	N.4 - 50A 500V gG (14 x 51 mm)	N.4 - 50A 500V gG (14 x 51 mm)

TABLE 4
UPS Trimod® BATTERY/2 Recommended Battery Fuse Ratings

POWER	BATTERY FUSE	
	Trimod® BATTERY/2 5KB	
	F B+	F B-
10/15/20/30/40/60 kVA	N.5 - 50A 500V gG (14 x 51 mm)	N.5 - 50A 500V gG (14 x 51 mm)

TABLE 5
UPS Trimod® BATTERY (1x94Ah) Recommended Battery Fuse Ratings

POWER	BATTERY FUSE	
	Trimod® BATTERY (1x94Ah)	
	F B+	F B-
10 kVA	N.1 - 50A 500V gG (22 x 58 mm)	N.1 - 50A 500V gG (22 x 58 mm)
15/20 kVA	N.1 - 100A 500V gG (22 x 58 mm)	N.1 - 100A 500V gG (22 x 58 mm)
30 kVA TT/TM	N.2 - 80A 500V gG (22 x 58 mm)	N.2 - 80A 500V gG (22 x 58 mm)
40 kVA	N.2 - 125A 500V gG (22 x 58 mm)	N.2 - 125A 500V gG (22 x 58 mm)
60 kVA	N.3 - 100A 500V gG (22 x 58 mm)	N.3 - 100A 500V gG (22 x 58 mm)

11. Tables

TABLE 6
Recommended Input Automatic Breaker

POWER	RECOMMENDED INPUT AUTOMATIC BREAKER	RECOMMENDED FUSES	INPUT PHASES / OUTPUT PHASES
10 kVA	20A (3P+N) curve C	20A gG	3φ / 3 φ
	63A (3P+N) curve C	63A gG	3φ / 1 φ
	63A (1P+N) curve C	63A gG	1φ / 1 - 3 φ
15 kVA	32A (3P+N) curve C	32A gG	3φ / 3 φ
	100A (3P+N) curve C	100A gG	3φ / 1 φ
	100A (1P+N) curve C	100A gG	1φ / 1 - 3 φ
20 kVA	40A (3P+N) curve C	32A gG	3φ / 3 φ
	100A (3P+N) curve C	100A gG	3φ / 1 φ
	100A (1P+N) curve C	100A gG	1φ / 1 - 3 φ
30 kVA TM	63A (3P+N) curve C	63A gG	3φ / 3 φ
	160A (3P+N) curve C	160A gG	3φ / 1 φ
	160A (1P+N) curve C	160A gG	1φ / 1 - 3 φ
30 kVA TT	63A (3P+N) curve C	63A gG	3φ / 3 φ
40 kVA	80A (3P+N) curve C	63A gG	3φ / 3 φ
60 kVA	100A (3P+N) curve C	100A gG	3φ / 3 φ

TABLE 7
Differential Breaker - Differential Current

POWER	DIFFERENTIAL BREAKER - DIFFERENTIAL CURRENT
10 kVA	≥ 300 mA B type
15 kVA	≥ 300 mA B type
20 kVA	≥ 300 mA B type
30 kVA TT/TM	≥ 300 mA B type
40 kVA	≥ 300 mA B type
60 kVA	≥ 300 mA B type

TABLE 8
Battery Current (100% Load) and Minimal Recommended Cable Sections

POWER	BATTERY CURRENT	MINIMAL RECOMMENDED CABLE SECTION
10 kVA	47A	1 x 10 mm ² for each pole
15 kVA	70A	1 x 16 mm ² for each pole
20 kVA	94A	1 x 25 mm ² for each pole
30 kVA TT/TM	141A	1 x 50 mm ² for each pole
40 kVA	188A	2 x 25 mm ² for each pole
60 kVA	282A	2 x 50 mm ² for each pole

**World Headquarters and
International Department**
87045 LIMOGES CEDEX FRANCE
☎: 33 5 55 06 87 87
Fax : 33 5 55 06 74 55
www.legrandelectric.com

┌ Installer stamp ─┐
└──────────────────┘

┌ ───────────────────┘

└ ───────────────────┘